

SAMSUNG

Mobile Device SM-G973F Common

SERVICE Manual

Mobile Device

CONTENTS



1. Safety Precautions
2. Specification
3. Product Function
4. Exploded View and Parts list
5. MAIN Electrical Parts List
6. Level 1 Repair
7. Level 2 Repair
8. Level 3 Repair
9. Reference Abbreviation

Notice: All functionality, features, specifications, and other product information provided in this document, including but not limited to, benefits, design, pricing, components, performance, availability, and capabilities of the product are subject to change without notice. Samsung reserves the right to alter this document or the product described herein at anytime, without obligation to provide notification of such changes.

1. Safety Precautions

1-1. Repair Precaution

Before attempting any repair or detailed tuning, shield the device from RF noise or static electricity discharges.

Use only demagnetized tools that are specifically designed for small electronic repairs, as most electronic parts are sensitive to electromagnetic forces.

Use only high quality screwdrivers when servicing products. Low quality screwdrivers can easily damage the heads of screws.

Use only conductor wire of the properly gauge and insulation for low resistance, because of the low margin of error of most testing equipment.

We recommend 22-gauge twisted copper wire.

Hand-soldering is not recommended, because printed circuit boards (PCBs) can be easily damaged, even with relatively low heat. Never use a soldering iron with a power rating of more than 100 watts and use only lead-free solder with a melting point below 250°C (482°F).

Prior to disassembling the battery charger for repair, ensure that the AC power is disconnected.

Always use the replacement parts that are registered in the SEC system. Third-party replacement parts may not function properly.

1. Safety Precautions

1-2. ESD(Electrostatically Sensitive Devices) Precaution

Many semiconductors and ESDs in electronic devices are particularly sensitive to static discharge and can be easily damaged by it. We recommend protecting these components with conductive anti-static bags when you store or transport them.

Always use an anti-static strap or wristband and remove electrostatic buildup or dissipate static electricity from your body before repairing ESDs.

Ensure that soldering irons have AC adapter with ground wires and that the ground wires are properly connected.

Use only desoldering tools with plastic tips to prevent static discharge.

Properly shield the work environment from accidental electrostatic discharge before opening packages containing ESDs.

The potential for static electricity discharge may be increased in low humidity environments, such as air-conditioned rooms. Increase the airflow to the working area to decrease the chance of accidental static electricity discharges.

2. Specification

2-1. GSM General Specification

Item		GSM 850	EGSM 900	DCS1800	PCS1900
Freq. Band[MHz]		824~849	880~915	1710~1785	1850~1910
Uplink/Downlink		869~894	925~960	1805~1880	1930~1990
ARFCN range		128~251	0~124 & 975~1023	512~885	512~810
Tx/Rx spacing		45MHz	45MHz	95MHz	80MHz
Mod. Bit rate/ Bit Period		270.833kbps 3.692us	270.833kbps 3.692us	270.833kbps 3.692us	270.833kbps 3.692us
Time Slot Period/ Frame Period		576.9us 4.615ms	576.9us 4.615ms	576.9us 4.615ms	576.9us 4.615ms
Modulation	GSM/ EGPRS	GMSK/ 8PSK	GMSK/ 8PSK	GMSK/ 8PSK	GMSK/ 8PSK
MS Power		33dBm~5dBm	33dBm~5dBm	30dBm~0dBm	30dBm~0dBm
Power Class		4(GMSK) E2(8PSK)	4(GMSK) E2(8PSK)	1(GMSK) E2(8PSK)	1(GMSK) E2(8PSK)
Sensitivity		-102dBm	-102dBm	-100dBm	-100dBm
TDMA Mux		8	8	8	8

2. Specification

2-2. WCDMA General Specification

Item	WCDMA 2100(B1)	WCDMA 1900(B2)	WCDMA AWS(B4)	WCDMA 850(B5)	WCDMA 900(B8)
Freq. Band[MHz] Uplink/Downlink	1920~1980 2110~2170	1850~1910 1930~1990	1710~1755 2110~2155	824~849 869~894	880~915 925~960
ARFCN range	UL: 9612~9888 DL: 10562~10838	UL: 9262~9538 DL: 9662~9938	UL: 1312~1513 DL: 1537~1738	UL: 4132~4233 DL: 4357~4458	UL: 2712~2868 DL: 2937~3088
Tx/Rx spacing	190MHz	80MHz	400MHz	45MHz	45MHz
Mod. Bit rate/ Bit Period	42.2Mbps(DL) 5.42Mbps(UL)	42.2Mbps(DL) 5.42Mbps(UL)	42.2Mbps(DL) 5.42Mbps(UL)	42.2Mbps(DL) 5.42Mbps(UL)	42.2Mbps(DL) 5.42Mbps(UL)
Time Slot Period/ Frame Period	WCDMA 10ms/0.667ms HSPA 2ms/0.667ms	WCDMA 10ms/0.667ms HSPA 2ms/0.667ms	WCDMA 10ms/0.667ms HSPA 2ms/0.667ms	WCDMA 10ms/0.667ms HSPA 2ms/0.667ms	WCDMA 10ms/0.667ms HSPA 2ms/0.667ms
Modulation	QPSK 16QAM 64QAM	QPSK 16QAM 64QAM	QPSK 16QAM 64QAM	QPSK 16QAM 64QAM	QPSK 16QAM 64QAM
MS Power (dBm)	25.7 ~ -49(↓)	25.7 ~ -49(↓)	25.7 ~ -49(↓)	25.7 ~ -49(↓)	25.7 ~ -49(↓)
Power Class	3(max+24dBm)	3(max+24dBm)	3(max+24dBm)	3(max+24dBm)	3(max+24dBm)
Sensitivity	-106dBm	-104dBm	-106dBm	-104dBm	-103dBm

2. Specification

2-3. LTE General Specification

Item	LTE Band1	LTE Band2	LTE Band3	LTE Band4	LTE Band5
Freq. Band[MHz] Uplink/Downlink	1920~1980 2110~2170	1850~1910 1930~1990	1710~1785 1805~1880	1710~1755 2110~2155	824~849 869~894
ARFCN range	UL:18000~18599 DL:0~599	UL:18600~19199 DL:600~1199	UL:19200~19949 DL:1200~1949	UL:19950~20399 DL:1950~2399	UL:20400~20649 DL:2400~2649
Tx/Rx spacing (MHz)	190	80	95	400	45
Channel Bandwidth (MHz)	5/10/15/20	1.4/3/5/10/15/20	1.4/3/5/10/15/20	1.4/3/5/10/15/20	1.4/3/5/10
Modulation	QPSK, 16/64QAM 256QAM(DL only)	QPSK, 16/64QAM 256QAM(DL only)	QPSK, 16/64QAM 256QAM(DL only)	QPSK, 16/64QAM 256QAM(DL only)	QPSK, 16/64QAM 256QAM(DL only)
MS Power (dBm)	25.7~-39(↓)	25.7~-39(↓)	25.7~-39(↓)	25.7~-39(↓)	25.7~-39(↓)
Sensitivity (QPSK, BW 10MHz) (dBm)	-96.3	-94.3	-93.3	-96.3	-94.3

Item	LTE Band7	LTE Band8	LTE Band12	LTE Band13	LTE Band17
Freq. Band[MHz] Uplink/Downlink	2500~2570 2620~2690	880~915 925~960	699~716 729~746	777~787 746~756	704~716 734~746
ARFCN range	UL:20750~21449 DL:2750~3449	UL:21450~21799 DL:3450~3799	UL:23010~23179 DL:5010~5179	UL:23180~23279 DL:5180~5279	UL:23730~23849 DL:5730~5849
Tx/Rx spacing (MHz)	120	45	30	-31	30
Channel Bandwidth (MHz)	5/10/15/20	1.4/3/5/10	1.4/3/5/10	5/10	5/10
Modulation	QPSK, 16/64QAM 256QAM(DL only)	QPSK, 16/64QAM 256QAM(DL only)	QPSK, 16/64QAM 256QAM(DL only)	QPSK, 16/64QAM 256QAM(DL only)	QPSK, 16/64QAM 256QAM(DL only)
MS Power (dBm)	25.7~-39(↓)	25.7~-39(↓)	25.7~-39(↓)	25.7~-39(↓)	25.7~-39(↓)
Sensitivity (QPSK, BW 10MHz) (dBm)	-94.3	-93.3	-93.3	-93.3	-93.3

2. Specification

Item	LTE Band18	LTE Band19	LTE Band20	LTE Band25	LTE Band26	LTE Band28
Freq. Band[MHz]	815~830	830~845	832~862	1850~1915	814~849	703~748
Uplink/Downlink	860~875	875~890	791~821	1930~1995	859~894	758~803
ARFCN range	UL:23850~23999 DL:5850~5999	UL:24000~24149 DL:6000~6149	UL:24150~24449 DL:6150~6449	UL:26040~26689 DL:8040~8689	UL:26690~27039 DL:8690~9039	UL:27210~27659 DL:9210~9659
Tx/Rx spacing (MHz)	45	45	-41	80	45	55
Channel Bandwidth (MHz)	5/10/15	5/10/15	5/10/15/20	1.4/3/5/10/15/20	1.4/3/5/10/15	3/5/10/15/20
Modulation	QPSK,16/64QAM 256QAM(DL only)	QPSK,16/64QAM 256QAM(DL only)	QPSK,16/64QAM 256QAM(DL only)	QPSK,16/64QAM 256QAM(DL only)	QPSK,16/64QAM 256QAM(DL only)	QPSK,16/64QAM 256QAM(DL only)
MS Power (dBm)	25.7~-39(↓)	25.7~-39(↓)	25.7~-39(↓)	25.7~-39(↓)	25.7~-39(↓)	25.7~-39(↓)
Sensitivity (QPSK, BW 10MHz) (dBm)	-96.3	-96.3	-93.3	-92.8	-93.8	-94.8

2. Specification

Item	LTE Band32	LTE Band38	LTE Band39	LTE Band40	LTE Band41	LTE Band66
Freq. Band[MHz] Uplink/Downlink	N/A 1452~1496	2570~2620	1880~1920	2300~2400	2496~2690	1710~1780 2110~2200
ARFCN range	DL:9920~10359	UL/DL:37750 ~ 38249	UL/DL:38250 ~ 38649	UL/DL:38650 ~ 39649	UL/DL:39650 ~ 41589	UL:131972 ~ 132671 DL:66436 ~ 67335
Tx/Rx spacing (MHz)	N/A	0	0	0	0	400
Channel Bandwidth (MHz)	5/10/15/20	5/10/15/20	5/10/15/20	5/10/15/20	5/10/15/20	1.4/3/5/10/15/20
Modulation	QPSK,16/64QAM 256QAM(DL only)	QPSK,16/64QAM 256QAM(DL only)	QPSK,16/64QAM 256QAM(DL only)	QPSK,16/64QAM 256QAM(DL only)	QPSK,16/64QAM 256QAM(DL only)	QPSK,16/64QAM 256QAM(DL only)
MS Power (dBm)	25.7~-39(↓)	25.7~-39(↓)	25.7~-39(↓)	25.7~-39(↓)	25.7~-39(↓)	25.7~-39(↓)
Sensitivity (QPSK, BW 10MHz) (dBm))	-96.3	-96.3	-96.3	-96.3	-94.3	-95.8

2. Specification

2-4. TDSCDMA General Specification

Item	TDSCDMA2010(A)	TDSCDMA1880(F)
Chip rate	1.28 Mcps	1.28 Mcps
OBW	1.6 MHz	1.6 MHz
Freq. Band[MHz] Uplink/Downlink	2010~2025	1880~1920
ARFCN range	10054~10121	9404~9596
Tx/Rx spacing (MHz)	0	0
MS Power (dBm)	25.7 ~ -48(↓)	25.7 ~ -48(↓)
Power Class	2(max+24dBm)	2(max+24dBm)
Sensitivity (dBm /1.28 MHz)	-107.3	-107.3

2. Specification

2-5. GSM Tx Power Class

TX Power Control level	GSM850	TX Power Control level	EGSM900	TX Power Control level	DCS1800	TX Power Control level	PCS1900
5	33±2 dBm	5	33±2 dBm	0	30±3 dBm	0	30±3 dBm
6	31±2 dBm	6	31±2 dBm	1	28±3 dBm	1	28±3 dBm
7	29±2 dBm	7	29±2 dBm	2	26±3 dBm	2	26±3 dBm
8	27±2 dBm	8	27±2 dBm	3	24±3 dBm	3	24±3 dBm
9	25±2 dBm	9	25±2 dBm	4	22±3 dBm	4	22±3 dBm
10	23±2 dBm	10	23±2 dBm	5	20±3 dBm	5	20±3 dBm
11	21±2 dBm	11	21±2 dBm	6	18±3 dBm	6	18±3 dBm
12	19±2 dBm	12	19±2 dBm	7	16±3 dBm	7	16±3 dBm
13	17±2 dBm	13	17±2 dBm	8	14±3 dBm	8	14±3 dBm
14	15±2 dBm	14	15±2 dBm	9	12±4 dBm	9	12±4 dBm
15	13±2 dBm	15	13±2 dBm	10	10±4 dBm	10	10±4 dBm
16	11±3 dBm	16	11±3 dBm	11	8±4 dBm	11	8±4 dBm
17	9±3dBm	17	9±3dBm	12	6±4 dBm	12	6±4 dBm
18	7±3 dBm	18	7±3 dBm	13	4±4 dBm	13	4±4 dBm
19	5±3 dBm	19	5±3 dBm	14	2±5 dBm	14	2±5 dBm
-	-	-	-	15	0±5 dBm	15	0±5 dBm

3. Product Function

Main Function

Item	Description
OS	Android V9.0
RF	2G GSM : GSM850 / GSM900 / DCS1800 / PCS1900 3G WCDMA : B1 / B2 / B4 / B5 / B8 TD-SCDMA : B34 / B39 4G (LTE) - FDD : B1 / B2 / B3 / B4 / B5 / B7 / B8 / B12 / B13 / B17 / B18 / B19 / B20 / B25 / B26 / B28 / B32 / B66 - TDD : B38 / B39 / B40 / B41
Battery	Typ : 3400mAh / Rated : 3300mAh
Base Band	EXYNOS9820 Quad 2.7GHz(2x), 2.3GHz(2x), 1.9GHz(4x)
Other RF	GPS, GLONASS, BEIDOU, Galileo, BT5.0, USB 3.1 Type-C, Wi-Fi 802.11 a/b/g/n/ac/ax MIMO, NFC, MST
Camera	Triple Camera (Wide: 12M, A/F, OIS, F1.5-2.4 / Tele: 12MP, A/F, OIS, F2.4 / Ultra Wide: 16M, F2.2) with LED Flash, Front Camera (10M, A/F, F1.9)
LCD	6.1" Quad HD+, 3040 x 1440, Dynamic AMOLED
RAM	6GB or 8GB
Storage	128GB or 512GB (512GB storage only for 8GB RAM)
Sensor	Accelerometer, Barometer, Fingerprint Sensor, Gyro Sensor, Geomagnetic Sensor, Hall Sensor, HR Sensor, Proximity Sensor, RGB Light Sensor
Accessory	Charger : 5V/2A or 9V/1.67A Data cable : USB Type-C Ear jack : 3.5pi, 4Pin

4. Exploded View and Parts List

4-1. Cellular phone Exploded View

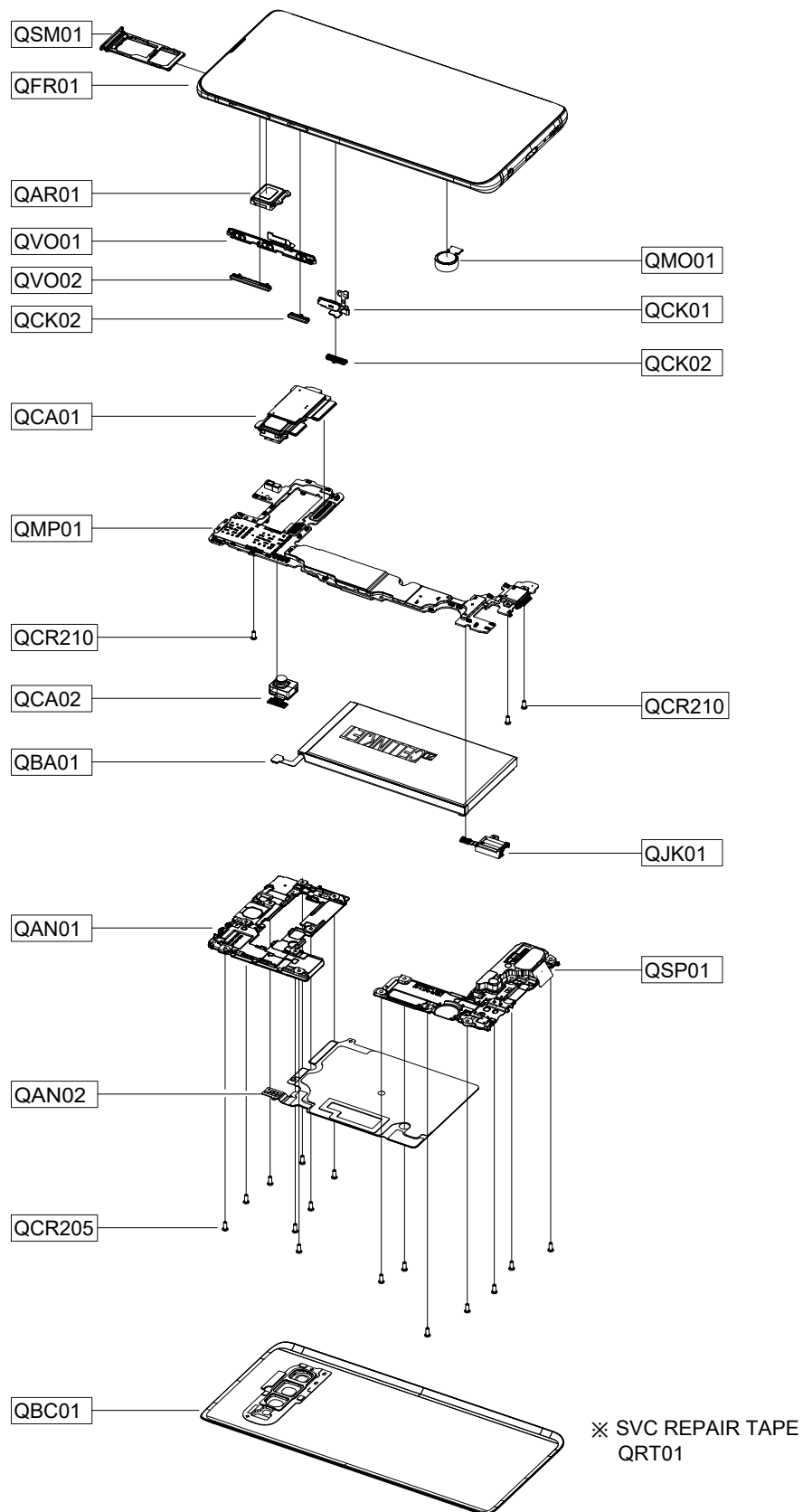

5. MAIN Electrical Parts List

Parts code	Desing Loc	Description
R4009,R4027,R9028	0202-002125	-
U12031	0202-002125	-
D8001	0401-001110	Diode
D8000,D9000	0404-001250	Diode
ZD9005	0406-001561	Diode
ZD9003	0406-001709	Diode
ZD8005,ZD8007	0406-001729	Diode
ZD9001,ZD9004	0406-001781	Diode
ZD11011,ZD11018	0406-001787	Diode
ZD9007,ZD9008,ZD9009	0406-001787	Diode
ZD9010	0406-001787	Diode
ZD11009,ZD11010	0406-001804	Diode
ZD11014,ZD11015	0406-001804	Diode
ZD11016,ZD11017	0406-001804	Diode
ZD11021,ZD11022	0406-001804	Diode
ZD8003	0406-001805	Diode
ZD11012,ZD11013	0406-001809	Diode
ZD11007,ZD11020	0406-001826	Diode
LED10000	0601-003707	LED
U8036	0801-003639	IC
U10007	0903-002233	IC
U9036	1001-001755	IC
U1005	1001-001975	IC
U8025	1001-002045	IC
U1002,U1003,U1004	1001-002075	IC
U2000	1001-002075	IC
U11026,U5018	1009-001076	IC
UME4000	1107-002611	IC
U5008	1201-003735	IC
PAM1001	1201-004114	IC
PAM1000	1201-004157	IC
U9015,U9017	1201-004178	IC
U1006	1201-004210	IC
U12008	1202-001120	IC
U10002	1203-008472	IC
U4000	1203-008729	IC
U8008	1203-008802	IC
U5012	1203-008811	IC

Confidential and proprietary-the contents in this service guide subject to change without prior notice

Distribution, transmission, or infringement of any content or data from this document without Samsung's written authorization is strictly prohibited.

5. MAIN Electrical Parts List

U12014,U5011,U8035	1203-008867	IC
U12006	1203-009032	IC
U10000	1203-009035	IC
U9048	1203-009080	IC
U8031	1203-009156	IC
U8033	1203-009168	IC
U8015	1203-009187	IC
U12019	1203-009191	IC
U1008	1204-003761	IC
U1001	1204-003773	IC
U12023	1205-005217	IC
U9025	1205-005729	IC
U5025	1205-005871	IC
U5004	1205-005880	IC
U3000	1205-006032	IC
UCP5000	1205-006121	IC
U5024	1209-002513	IC
U5021	1209-002558	IC
U5023	1209-002567	IC
U5020	1209-002578	IC
U11022	1209-002607	IC
U5100	1209-002608	IC
U5101	1209-002619	THERMISTOR
TH11000,TH5000	1404-001724	THERMISTOR
TH6000,TH8000,TH8001	1404-001724	THERMISTOR
TH8002,U4002	1404-001724	THERMISTOR
V1003,V2013,V5011	1405-001395	VARISTOR
V7004,V7009,V7010	1405-001395	VARISTOR
V7011,V7014,V7019	1405-001395	VARISTOR
V7026,V7028	1405-001395	VARISTOR
V11001	1405-001404	VARISTOR
V1002	1405-001412	VARISTOR
U12029,V2000,V2001	1405-001415	VARISTOR
V2015,V3000,V5007	1405-001415	VARISTOR
V11000,V11006,V11008	1405-001420	VARISTOR
V5002,V5012,V7012	1405-001420	VARISTOR
V7023	1405-001420	VARISTOR
V5001	1405-001423	VARISTOR
V11002,V11003,V11004	1405-001428	VARISTOR

Confidential and proprietary-the contents in this service guide subject to change without prior notice

Distribution, transmission, or infringement of any content or data from this document without Samsung's written authorization is strictly prohibited.

5. MAIN Electrical Parts List

V11017,V7031	1405-001428	VARISTOR
V11012,V11013,V11014	1405-001445	VARISTOR
V1001	1405-001450	VARISTOR
V11007,V11015,V11016	1405-001458	VARISTOR
R11016,R11018,R11019	2007-001284	R-CHIP
R11021	2007-001284	R-CHIP
R11000	2007-007100	R-CHIP
R5032	2007-007142	R-CHIP
R9015,R9016	2007-007193	R-CHIP
R6001,R6031,R6078	2007-007310	R-CHIP
R5030,R5031	2007-007314	R-CHIP
R10006,R4000,R4001	2007-007741	R-CHIP
R4005,R5101,R8032	2007-007741	R-CHIP
R8033,R8039,R9006	2007-007741	R-CHIP
R9020	2007-007741	R-CHIP
R5105	2007-007798	R-CHIP
R6043	2007-007942	R-CHIP
R6045	2007-007946	R-CHIP
R3000	2007-008043	R-CHIP
R10009,R12004	2007-008052	R-CHIP
R12002,R8042	2007-008211	R-CHIP
R9010	2007-008294	R-CHIP
R10003	2007-008296	R-CHIP
R8041	2007-008403	R-CHIP
R11002	2007-008419	R-CHIP
R10002,R8036	2007-008486	R-CHIP
R8010,R8034,R8035	2007-008531	R-CHIP
R9011	2007-008531	R-CHIP
R11015,R11017,R11020	2007-008774	R-CHIP
R11022,R5102,R5103	2007-008774	R-CHIP
R4025	2007-008785	R-CHIP
R8038	2007-008809	R-CHIP
R5100	2007-009111	R-CHIP
R10005,R11014,R4015	2007-009157	R-CHIP
R4016,R5033,R6062	2007-009157	R-CHIP
R6063,R8015,R8016	2007-009157	R-CHIP
R8017,R8029,R8030	2007-009157	R-CHIP
R9014,R9017	2007-009157	R-CHIP
R5003,R7063	2007-009182	R-CHIP

Confidential and proprietary-the contents in this service guide subject to change without prior notice

Distribution, transmission, or infringement of any content or data from this document without Samsung's written authorization is strictly prohibited.

5. MAIN Electrical Parts List

R9003,R9004,R9005	2007-009201	R-CHIP
R9025	2007-009201	R-CHIP
R10018,R10019,R4002	2007-009212	R-CHIP
R4003,R4004,R4006	2007-009212	R-CHIP
R4007,R4026,R6023	2007-009212	R-CHIP
R6024,R6060,R6061	2007-009212	R-CHIP
R8040,R9007,R9019	2007-009212	R-CHIP
R8023,R8024	2007-009233	R-CHIP
R12005,R4024	2007-009314	R-CHIP
R11001,R12000,R5029	2007-009408	R-CHIP
R6027,R6028,R9012	2007-009408	R-CHIP
R5013,R5014	2007-009805	R-CHIP
R10007,R11010,R11011	2007-009866	R-CHIP
R11012,R11013,R8001	2007-009866	R-CHIP
R8031	2007-009866	R-CHIP
R10014,R10015,R6036	2007-009879	R-CHIP
R6037	2007-009879	R-CHIP
R11004,R11005	2007-009924	R-CHIP
R9009	2007-009969	R-CHIP
R8009,R8012,R8013	2007-010202	R-CHIP
R8025,R8026	2007-010685	R-CHIP
R6000	2007-011043	R-CHIP
R6051,R6052,R6054	2007-011262	R-CHIP
R6055,R6058,R6064	2007-011262	R-CHIP
R6065,R6066,R6067	2007-011262	R-CHIP
R6068,R6070,R6071	2007-011262	R-CHIP
R6073,R6074,R9026	2007-011262	R-CHIP
R5010,R5011	2007-011378	R-CHIP
R9024	2007-011532	R-CHIP
R10004,R12001,R12003	2007-011542	R-CHIP
R6038,R6039,R6040	2007-011546	R-CHIP
R6041,R6079,R6080	2007-011546	R-CHIP
R6081,R6082	2007-011546	R-CHIP
R3002,R3003,R3005	2007-011548	R-CHIP
R3006,R6044	2007-011548	R-CHIP
R5006,R5007,R5008	2007-011591	R-CHIP
R5009,R6002,R6003	2007-011591	R-CHIP
R6006,R6007,R6008	2007-011591	R-CHIP
R6009,R6012,R6013	2007-011591	R-CHIP

Confidential and proprietary-the contents in this service guide subject to change without prior notice

Distribution, transmission, or infringement of any content or data from this document without Samsung's written authorization is strictly prohibited.

5. MAIN Electrical Parts List

R6014,R6015,R6021	2007-011591	R-CHIP
R6022,R6025,R6026	2007-011591	R-CHIP
R6029,R6030,R6032	2007-011591	R-CHIP
R6033,R6034,R6035	2007-011591	R-CHIP
R6085,R6086,R8019	2007-011591	R-CHIP
R8020	2007-011591	R-CHIP
R6010,R6011,R6019	2007-011594	R-CHIP
R6020,R6091,R6092	2007-011594	R-CHIP
R6042	2007-011599	R-CHIP
R4012	2007-011648	R-CHIP
R8018	2007-012197	R-CHIP
R12010	2007-012202	R-CHIP
C8188,C8189	2203-000138	C-CERAMIC, CHIP
C5072,C5079	2203-000233	C-CERAMIC, CHIP
C5077	2203-000330	C-CERAMIC, CHIP
C5103,C8185	2203-000438	C-CERAMIC, CHIP
C8150	2203-000489	C-CERAMIC, CHIP
C8127,C8128	2203-000679	C-CERAMIC, CHIP
C8180,C8186	2203-000725	C-CERAMIC, CHIP
C11008,C8190,C8191	2203-000812	C-CERAMIC, CHIP
C8124	2203-001033	C-CERAMIC, CHIP
C11009	2203-002285	C-CERAMIC, CHIP
C5076	2203-005057	C-CERAMIC, CHIP
C10092,C10094,C10095	2203-005682	C-CERAMIC, CHIP
C14431,C2038	2203-005682	C-CERAMIC, CHIP
C1071	2203-005717	C-CERAMIC, CHIP
C9035,C9037,C9041	2203-005726	C-CERAMIC, CHIP
C9077	2203-005726	C-CERAMIC, CHIP
L2025	2203-005729	C-CERAMIC, CHIP
C2030,C2047,C9055	2203-005731	C-CERAMIC, CHIP
C9061,L2022	2203-005731	C-CERAMIC, CHIP
C9048,C9059,C9060	2203-005732	C-CERAMIC, CHIP
C9064,C9066,C9078	2203-005732	C-CERAMIC, CHIP
C10024	2203-005734	C-CERAMIC, CHIP
C1004,C10054,C10055	2203-005736	C-CERAMIC, CHIP
C10064,C10065,C10066	2203-005736	C-CERAMIC, CHIP
C10069,C1007,C10070	2203-005736	C-CERAMIC, CHIP
C10093,C1015,C1017	2203-005736	C-CERAMIC, CHIP
C1021,C1022,C1023	2203-005736	C-CERAMIC, CHIP

Confidential and proprietary-the contents in this service guide subject to change without prior notice

Distribution, transmission, or infringement of any content or data from this document without Samsung's written authorization is strictly prohibited.

5. MAIN Electrical Parts List

C1024,C1027,C1032	2203-005736	C-CERAMIC, CHIP
C1033,C1036,C1037	2203-005736	C-CERAMIC, CHIP
C1038,C1041,C1044	2203-005736	C-CERAMIC, CHIP
C1045,C1046,C1047	2203-005736	C-CERAMIC, CHIP
C1050,C1054,C1061	2203-005736	C-CERAMIC, CHIP
C1069,C1080,C1082	2203-005736	C-CERAMIC, CHIP
C1085,C11012,C1109	2203-005736	C-CERAMIC, CHIP
C1114,C1115,C1118	2203-005736	C-CERAMIC, CHIP
C1122,C1123,C14432	2203-005736	C-CERAMIC, CHIP
C2013,C2014,C2015	2203-005736	C-CERAMIC, CHIP
C2017,C2020,C2025	2203-005736	C-CERAMIC, CHIP
C2027,C2028,C2029	2203-005736	C-CERAMIC, CHIP
C2036,C2045,C2064	2203-005736	C-CERAMIC, CHIP
C2065,C3027,C3029	2203-005736	C-CERAMIC, CHIP
C4015,C5114,C5119	2203-005736	C-CERAMIC, CHIP
C5200,C5204,C5205	2203-005736	C-CERAMIC, CHIP
C8117,L1005,L1014	2203-005736	C-CERAMIC, CHIP
L1025,L1039,L1041	2203-005736	C-CERAMIC, CHIP
L1049,L1051,L1056	2203-005736	C-CERAMIC, CHIP
L1063,L1100,L2028	2203-005736	C-CERAMIC, CHIP
L2043,L5037	2203-005736	C-CERAMIC, CHIP
C1020,C1031,C1084	2203-005777	C-CERAMIC, CHIP
C2006	2203-005777	C-CERAMIC, CHIP
C10053,C10062,C10086	2203-005779	C-CERAMIC, CHIP
C1019,C1030,C1055	2203-005789	C-CERAMIC, CHIP
C1072,C1086,C1087	2203-005789	C-CERAMIC, CHIP
C1088,C2009,L5065	2203-005789	C-CERAMIC, CHIP
L2008	2203-005792	C-CERAMIC, CHIP
C5067	2203-005806	C-CERAMIC, CHIP
C1094,C9047	2203-006121	C-CERAMIC, CHIP
C2039,L1004	2203-006187	C-CERAMIC, CHIP
L2005	2203-006305	C-CERAMIC, CHIP
C2033,L2037	2203-006318	C-CERAMIC, CHIP
C2091,C3021,C3024	2203-006400	C-CERAMIC, CHIP
C3025,C4181	2203-006400	C-CERAMIC, CHIP
C1006,C2021	2203-006410	C-CERAMIC, CHIP
C1029,C1048,L1030	2203-006556	C-CERAMIC, CHIP
C2035	2203-006665	C-CERAMIC, CHIP
C4424,C6006	2203-006668	C-CERAMIC, CHIP

Confidential and proprietary-the contents in this service guide subject to change without prior notice

Distribution, transmission, or infringement of any content or data from this document without Samsung's written authorization is strictly prohibited.

5. MAIN Electrical Parts List

C1095	2203-006712	C-CERAMIC, CHIP
C1090,C1091,C1093	2203-006839	C-CERAMIC, CHIP
C1097,C1098,C1100	2203-006839	C-CERAMIC, CHIP
C5057,C8114,C8123	2203-006839	C-CERAMIC, CHIP
C8131,C8137	2203-006839	C-CERAMIC, CHIP
C11001,C11003,C11004	2203-006844	C-CERAMIC, CHIP
C11006,C3026	2203-006844	C-CERAMIC, CHIP
C3012,C3014,U4003	2203-006979	C-CERAMIC, CHIP
C2024	2203-007194	C-CERAMIC, CHIP
C4004,C7012	2203-007210	C-CERAMIC, CHIP
C1096	2203-007271	C-CERAMIC, CHIP
C4000,C4035,C5061	2203-007317	C-CERAMIC, CHIP
C5062,C7055,C7065	2203-007317	C-CERAMIC, CHIP
C7104,C7108,C7121	2203-007317	C-CERAMIC, CHIP
C9033,C9036,C9038	2203-007317	C-CERAMIC, CHIP
C9039,C9040,C9072	2203-007317	C-CERAMIC, CHIP
C9074,C9076	2203-007317	C-CERAMIC, CHIP
C10040,C9006,C9007	2203-007391	C-CERAMIC, CHIP
C9030	2203-007391	C-CERAMIC, CHIP
C1081,C1099	2203-007392	C-CERAMIC, CHIP
C10014,C10017,C10039	2203-007393	C-CERAMIC, CHIP
C10063,C1092,C12008	2203-007393	C-CERAMIC, CHIP
C12009,C5055,C5098	2203-007393	C-CERAMIC, CHIP
C5099,C5201,C8019	2203-007393	C-CERAMIC, CHIP
C8063,C8070,C8091	2203-007393	C-CERAMIC, CHIP
C8135,C8140,C8177	2203-007393	C-CERAMIC, CHIP
C9065,C9068	2203-007393	C-CERAMIC, CHIP
L1028	2203-007403	C-CERAMIC, CHIP
C8115	2203-007425	C-CERAMIC, CHIP
C9070	2203-007456	C-CERAMIC, CHIP
C9067	2203-007486	C-CERAMIC, CHIP
C5074,C8149,C8151	2203-007544	C-CERAMIC, CHIP
C8152,C8154,C8157	2203-007544	C-CERAMIC, CHIP
C8159,C8171	2203-007544	C-CERAMIC, CHIP
C10025,C10073,C10090	2203-007621	C-CERAMIC, CHIP
C11013,C2001,C2023	2203-007621	C-CERAMIC, CHIP
C2037,C3002,C3010	2203-007621	C-CERAMIC, CHIP
C3015,C3020,C3023	2203-007621	C-CERAMIC, CHIP
C4005,C4039,C4041	2203-007621	C-CERAMIC, CHIP

Confidential and proprietary-the contents in this service guide subject to change without prior notice

Distribution, transmission, or infringement of any content or data from this document without Samsung's written authorization is strictly prohibited.

5. MAIN Electrical Parts List

C5021,C5053,C5056	2203-007621	C-CERAMIC, CHIP
C5059,C5060,C5073	2203-007621	C-CERAMIC, CHIP
C5100,C5101,C6000	2203-007621	C-CERAMIC, CHIP
C6001,C8007,C8017	2203-007621	C-CERAMIC, CHIP
C8043,C8044,C8136	2203-007621	C-CERAMIC, CHIP
C8163,C9018,C9057	2203-007621	C-CERAMIC, CHIP
C9058	2203-007621	C-CERAMIC, CHIP
C5037	2203-007781	C-CERAMIC, CHIP
C10005,C10012,C10013	2203-007796	C-CERAMIC, CHIP
C1018,C1042,C11011	2203-007796	C-CERAMIC, CHIP
C12013,C12020,C12021	2203-007796	C-CERAMIC, CHIP
C12039,C3005,C3008	2203-007796	C-CERAMIC, CHIP
C3009,C3011,C3013	2203-007796	C-CERAMIC, CHIP
C3016,C3017,C3028	2203-007796	C-CERAMIC, CHIP
C3030,C4001,C5000	2203-007796	C-CERAMIC, CHIP
C5001,C5002,C5003	2203-007796	C-CERAMIC, CHIP
C5004,C5040,C5041	2203-007796	C-CERAMIC, CHIP
C5054,C5063,C5068	2203-007796	C-CERAMIC, CHIP
C5069,C5094,C7000	2203-007796	C-CERAMIC, CHIP
C7001,C7010,C7011	2203-007796	C-CERAMIC, CHIP
C7014,C7015,C7024	2203-007796	C-CERAMIC, CHIP
C7027,C7028,C7030	2203-007796	C-CERAMIC, CHIP
C7031,C7032,C7034	2203-007796	C-CERAMIC, CHIP
C7035,C7036,C7045	2203-007796	C-CERAMIC, CHIP
C7047,C7050,C7052	2203-007796	C-CERAMIC, CHIP
C7053,C7056,C7057	2203-007796	C-CERAMIC, CHIP
C7058,C7059,C7060	2203-007796	C-CERAMIC, CHIP
C7061,C7062,C7064	2203-007796	C-CERAMIC, CHIP
C7066,C7067,C7068	2203-007796	C-CERAMIC, CHIP
C7069,C7070,C7071	2203-007796	C-CERAMIC, CHIP
C7072,C7073,C7074	2203-007796	C-CERAMIC, CHIP
C7075,C7076,C7077	2203-007796	C-CERAMIC, CHIP
C7078,C7079,C7080	2203-007796	C-CERAMIC, CHIP
C7081,C7084,C7086	2203-007796	C-CERAMIC, CHIP
C7088,C7089,C7090	2203-007796	C-CERAMIC, CHIP
C7092,C7093,C7095	2203-007796	C-CERAMIC, CHIP
C7096,C7097,C7106	2203-007796	C-CERAMIC, CHIP
C7111,C7112,C7113	2203-007796	C-CERAMIC, CHIP
C7115,C7116,C7117	2203-007796	C-CERAMIC, CHIP

Confidential and proprietary-the contents in this service guide subject to change without prior notice

Distribution, transmission, or infringement of any content or data from this document without Samsung's written authorization is strictly prohibited.

5. MAIN Electrical Parts List

C7119,C8059,C8060	2203-007796	C-CERAMIC, CHIP
C8065,C8066,C8068	2203-007796	C-CERAMIC, CHIP
C8072,C8073,C8077	2203-007796	C-CERAMIC, CHIP
C8092,C8112,C8139	2203-007796	C-CERAMIC, CHIP
C8141,C8143,C8153	2203-007796	C-CERAMIC, CHIP
C8169,C8170,C8183	2203-007796	C-CERAMIC, CHIP
C9008,C9012,C9021	2203-007796	C-CERAMIC, CHIP
C9023,C9024,C9026	2203-007796	C-CERAMIC, CHIP
C9032,C9056,C9073	2203-007796	C-CERAMIC, CHIP
C8187	2203-007809	C-CERAMIC, CHIP
C8104	2203-008095	C-CERAMIC, CHIP
C8005,C8018,C8161	2203-008097	C-CERAMIC, CHIP
C9001,C9004,C9009	2203-008097	C-CERAMIC, CHIP
C9013,C9029,C9031	2203-008097	C-CERAMIC, CHIP
C8146,C8148,C8155	2203-008158	C-CERAMIC, CHIP
C8156	2203-008158	C-CERAMIC, CHIP
C8025	2203-008177	C-CERAMIC, CHIP
C10004,C10021,C10022	2203-008242	C-CERAMIC, CHIP
C10028,C10029,C10030	2203-008242	C-CERAMIC, CHIP
C10031,C10078,C10087	2203-008242	C-CERAMIC, CHIP
C10097,C12019,C12023	2203-008242	C-CERAMIC, CHIP
C12027,C4006,C5009	2203-008242	C-CERAMIC, CHIP
C5010,C5012,C7087	2203-008242	C-CERAMIC, CHIP
C7105,C8010,C8011	2203-008242	C-CERAMIC, CHIP
C8028,C8029,C8030	2203-008242	C-CERAMIC, CHIP
C8031,C8055,C8056	2203-008242	C-CERAMIC, CHIP
C8057,C8061,C8062	2203-008242	C-CERAMIC, CHIP
C8064,C8071,C8074	2203-008242	C-CERAMIC, CHIP
C8090,C8162,C9014	2203-008242	C-CERAMIC, CHIP
C8103	2203-008243	C-CERAMIC, CHIP
C1064	2203-008394	C-CERAMIC, CHIP
C1051,C4036	2203-008400	C-CERAMIC, CHIP
C1028,C4017,C4019	2203-008466	C-CERAMIC, CHIP
C4020,C4021,C5011	2203-008466	C-CERAMIC, CHIP
C5036,C5206,C5207	2203-008466	C-CERAMIC, CHIP
C9016,C9050,L2018	2203-008466	C-CERAMIC, CHIP
C1016,C5096,C5097	2203-008529	C-CERAMIC, CHIP
C1078,C2000,C2063	2203-008563	C-CERAMIC, CHIP
C4013,C4014,C4016	2203-008563	C-CERAMIC, CHIP

Confidential and proprietary-the contents in this service guide subject to change without prior notice

Distribution, transmission, or infringement of any content or data from this document without Samsung's written authorization is strictly prohibited.

5. MAIN Electrical Parts List

C4018,C5038,C5071	2203-008563	C-CERAMIC, CHIP
C5080,C6003,C6004	2203-008563	C-CERAMIC, CHIP
C8132,C8133,C8158	2203-008563	C-CERAMIC, CHIP
C8118,C8144,C8145	2203-008572	C-CERAMIC, CHIP
C8160,C8178	2203-008572	C-CERAMIC, CHIP
C6002	2203-008653	C-CERAMIC, CHIP
C4010,C5039,C5095	2203-008689	C-CERAMIC, CHIP
C5203	2203-008689	C-CERAMIC, CHIP
C10006,C10007,C10008	2203-008844	C-CERAMIC, CHIP
C10023	2203-008844	C-CERAMIC, CHIP
C1110,C1111,C12010	2203-008860	C-CERAMIC, CHIP
C12028,C12038,C12041	2203-008860	C-CERAMIC, CHIP
C12045,C3001,C8134	2203-008860	C-CERAMIC, CHIP
C8176,C8179	2203-008860	C-CERAMIC, CHIP
C10003,C10018,C10019	2203-008876	C-CERAMIC, CHIP
C10020,C10034,C10036	2203-008876	C-CERAMIC, CHIP
C10037,C10038,C10041	2203-008876	C-CERAMIC, CHIP
C10056,C10071,C10079	2203-008876	C-CERAMIC, CHIP
C10083,C10091,C10098	2203-008876	C-CERAMIC, CHIP
C10103,C1079,C12017	2203-008876	C-CERAMIC, CHIP
C12022,C12026,C12029	2203-008876	C-CERAMIC, CHIP
C12046,C4011,C8004	2203-008876	C-CERAMIC, CHIP
C8006,C8008,C8009	2203-008876	C-CERAMIC, CHIP
C8012,C8013,C8014	2203-008876	C-CERAMIC, CHIP
C8016,C8020,C8021	2203-008876	C-CERAMIC, CHIP
C8032,C8037,C8038	2203-008876	C-CERAMIC, CHIP
C8041,C8042,C8045	2203-008876	C-CERAMIC, CHIP
C8047,C8050,C8052	2203-008876	C-CERAMIC, CHIP
C8053,C8067,C8089	2203-008876	C-CERAMIC, CHIP
C8100,C8113,C8164	2203-008876	C-CERAMIC, CHIP
C9027,C9044,C9045	2203-008876	C-CERAMIC, CHIP
C11000,C11002,C11005	2203-008886	C-CERAMIC, CHIP
C11007	2203-008886	C-CERAMIC, CHIP
C7002,C7003,C7005	2203-009064	C-CERAMIC, CHIP
C7007,C7008,C7018	2203-009064	C-CERAMIC, CHIP
C7019,C7020,C7022	2203-009064	C-CERAMIC, CHIP
C7051,C7114	2203-009064	C-CERAMIC, CHIP
C5075,C5078	2203-009167	C-CERAMIC, CHIP
C8106,C9071	2203-009444	C-CERAMIC, CHIP

Confidential and proprietary-the contents in this service guide subject to change without prior notice

Distribution, transmission, or infringement of any content or data from this document without Samsung's written authorization is strictly prohibited.

5. MAIN Electrical Parts List

C12014,C12015,C7048	2203-009537	C-CERAMIC, CHIP
C12043	2203-009551	C-CERAMIC, CHIP
C12001,C12002,C12003	2203-009618	C-CERAMIC, CHIP
C12004,C12005	2203-009618	C-CERAMIC, CHIP
C10010,C10011,C10016	2203-009733	C-CERAMIC, CHIP
C10042,C10061,C10100	2203-009733	C-CERAMIC, CHIP
C1101,C1116,C12006	2203-009733	C-CERAMIC, CHIP
C4002,C4012,C5058	2203-009733	C-CERAMIC, CHIP
C8022,C8069,C8088	2203-009733	C-CERAMIC, CHIP
C9011,C9043	2203-009733	C-CERAMIC, CHIP
C7098,C7102	2203-009735	C-CERAMIC, CHIP
C10026,C10046,C10047	2203-009736	C-CERAMIC, CHIP
C10051,C10052,C10057	2203-009736	C-CERAMIC, CHIP
C10058,C10059,C10060	2203-009736	C-CERAMIC, CHIP
C10067,C10068,C10072	2203-009736	C-CERAMIC, CHIP
C10074,C10075,C10076	2203-009736	C-CERAMIC, CHIP
C10077,C10080,C10096	2203-009736	C-CERAMIC, CHIP
C10101,C10102,C3019	2203-009736	C-CERAMIC, CHIP
C3022,C9019	2203-009736	C-CERAMIC, CHIP
C8119	2203-009812	C-CERAMIC, CHIP
C8105	2203-009848	C-CERAMIC, CHIP
C12007,C5065,C5066	2203-009858	C-CERAMIC, CHIP
C5070,C8000,C8001	2203-009858	C-CERAMIC, CHIP
C8002,C8003,C8125	2203-009858	C-CERAMIC, CHIP
C8126,C8129,C8138	2203-009858	C-CERAMIC, CHIP
C10001,C10009,C12000	2203-009859	C-CERAMIC, CHIP
C12011,C12012	2203-009859	C-CERAMIC, CHIP
C9000,C9002,C9003	2203-009969	C-CERAMIC, CHIP
C9042	2203-009969	C-CERAMIC, CHIP
C10027,C10043,C10044	2203-009987	C-CERAMIC, CHIP
C10045,C4008,C4009	2203-009987	C-CERAMIC, CHIP
C8085,C8086,C8087	2203-009987	C-CERAMIC, CHIP
C8040,C8081,C8082	2203-010085	C-CERAMIC, CHIP
C8083,C8084,C8172	2203-010085	C-CERAMIC, CHIP
C10002,C10099,C8051	2203-010127	C-CERAMIC, CHIP
TA8006,TA8007	2409-001387	TANTAL
TA8000,TA8001,TA8002	2409-001400	TANTAL
TA8003,TA8004,TA8005	2409-001400	TANTAL
L1017,L2017,L2035	2703-002907	INDUCTOR

Confidential and proprietary-the contents in this service guide subject to change without prior notice

Distribution, transmission, or infringement of any content or data from this document without Samsung's written authorization is strictly prohibited.

5. MAIN Electrical Parts List

L2049	2703-002907	INDUCTOR
C1113,C2005,L1001	2703-002958	INDUCTOR
L1006,L1021,L1022	2703-002958	INDUCTOR
L1050,L2002,L2019	2703-002958	INDUCTOR
L10006,L10007,L10013	2703-002959	INDUCTOR
L1011	2703-002961	INDUCTOR
C2012	2703-002999	INDUCTOR
C1062,C2008,C5112	2703-004012	INDUCTOR
L2032,L5054,L5078	2703-004012	INDUCTOR
C1039,C1067,C1068	2703-004013	INDUCTOR
C2044,L1053,L2026	2703-004013	INDUCTOR
L2029	2703-004013	INDUCTOR
L5053,L5067	2703-004014	INDUCTOR
C1014,L1013	2703-004018	INDUCTOR
L1029,L1058,L1061	2703-004033	INDUCTOR
L2023	2703-004033	INDUCTOR
C1005,C1065,C1119	2703-004034	INDUCTOR
C2022,C5111,L2012	2703-004034	INDUCTOR
L2047,L4009,L5074	2703-004034	INDUCTOR
L1032	2703-004035	INDUCTOR
L2020,L5025	2703-004036	INDUCTOR
C1034,C1049,C1053	2703-004038	INDUCTOR
C2043,L1008,L1024	2703-004038	INDUCTOR
L1026,L1031,L1055	2703-004038	INDUCTOR
L1082,L2006	2703-004038	INDUCTOR
L1062,L2038	2703-004287	INDUCTOR
L5048,L5055	2703-004366	INDUCTOR
L1015	2703-004369	INDUCTOR
L8028,L8029	2703-004841	INDUCTOR
L1003,L1070,L11008	2703-004853	INDUCTOR
C1060,L1083,L4001	2703-005058	INDUCTOR
L10001,L10002,L10003	2703-005067	INDUCTOR
L12002,L5035	2703-005067	INDUCTOR
C1026,C5116,L1037	2703-005085	INDUCTOR
L1046,L1054,L1059	2703-005085	INDUCTOR
L1060,L12012,L2024	2703-005085	INDUCTOR
L2066	2703-005085	INDUCTOR
L1033,L1042,L5080	2703-005086	INDUCTOR
L5036	2703-005087	INDUCTOR

Confidential and proprietary-the contents in this service guide subject to change without prior notice

Distribution, transmission, or infringement of any content or data from this document without Samsung's written authorization is strictly prohibited.

5. MAIN Electrical Parts List

L1010,L1019,L1064	2703-005088	INDUCTOR
L2009	2703-005088	INDUCTOR
L2027	2703-005089	INDUCTOR
L5046,L5047	2703-005200	INDUCTOR
L8001,L8003,L8004	2703-005201	INDUCTOR
L8005,L8008,L8009	2703-005201	INDUCTOR
L8010,L8011,L8017	2703-005201	INDUCTOR
L8023,L8026	2703-005201	INDUCTOR
L12000	2703-005224	INDUCTOR
L10000,L4000,L8027	2703-005225	INDUCTOR
L8024,L8025,L9000	2703-005233	INDUCTOR
L9001,L9005,L9011	2703-005233	INDUCTOR
L2046	2703-005296	INDUCTOR
L12001	2703-005418	INDUCTOR
L1066	2703-005430	INDUCTOR
L1069,L9002,L9003	2703-005505	INDUCTOR
L8000,L8006,L8007	2703-005509	INDUCTOR
L8012,L8013,L8014	2703-005509	INDUCTOR
L8015,L8016,L8018	2703-005509	INDUCTOR
L5043,L5044	2703-005555	INDUCTOR
L1007,L1027,L2033	2703-005614	INDUCTOR
L12004,L12005	2703-005663	INDUCTOR
OSC8000	2801-005393	CRYSTAL OSCILLATOR
OSC5000	2805-001118	CRYSTAL OSCILLATOR
TCX3000	2805-001128	CRYSTAL OSCILLATOR
C7004,C7006,C7017	2901-001690	FILTER
C7021,C7037,C7038	2901-001690	FILTER
C7039,C7040,C7049	2901-001690	FILTER
C7054,C7063,C7094	2901-001690	FILTER
C7099,C7100,C7101	2901-001690	FILTER
C7103,C7107	2901-001690	FILTER
F2002	2904-002270	FILTER
F1002	2904-002296	FILTER
U5014	2904-002356	FILTER
U1007,U2001	2904-002362	FILTER
F2000	2904-002378	FILTER
F2001	2904-002382	FILTER
F5001,F5003	2904-002401	FILTER
F1001	2904-002403	FILTER

Confidential and proprietary-the contents in this service guide subject to change without prior notice

Distribution, transmission, or infringement of any content or data from this document without Samsung's written authorization is strictly prohibited.

5. MAIN Electrical Parts List

FEM2000	2911-000453	IC
FEM2001,FEM2002	2911-000455	IC
MIC9000,MIC9001	3003-001243	MIC
L9006	3301-001885	BEAD
L12010	3301-001989	BEAD
L10004,L10005,L10011	3301-002223	BEAD
L10012,L10016	3301-002223	BEAD
L9004	3301-002228	BEAD
L11009,L11010,L5041	3301-002235	BEAD
L5042	3301-002235	BEAD
L1009,L1016,L1018	3301-002237	BEAD
L1034,L2000,L2001	3301-002237	BEAD
L2004,L2007,L2011	3301-002237	BEAD
L2014,L5032,L5033	3301-002237	BEAD
L9010	3301-002237	BEAD
L1071,L12009,L5102	3301-002238	BEAD
L12003,L5153	3301-002239	BEAD
L1012	3301-002243	BEAD
L1067	3301-002244	BEAD
L10008,L10009,L10017	3301-002279	BEAD
L1065,L12006,L12007	3301-002312	BEAD
L12008,L4006,L5045	3301-002312	BEAD
L5100,L5101	3301-002312	BEAD
L8020,L8021,L9009	3301-002331	BEAD
L9007,L9008	3301-002375	BEAD
RFS1000,RFS1001	3705-001708	CONNECTOR
CN4000	3709-001892	CONNECTOR
HDC8000	3711-008847	CONNECTOR
HEA8001	3711-008997	CONNECTOR
HEA10001,HEA12000	3711-009359	CONNECTOR
HEA10000,HEA10002	3711-009407	CONNECTOR
ANT1005,ANT1006	3712-001604	C_CLIP
ANT1010,ANT1014	3712-001604	C_CLIP
ANT11000,ANT11002	3712-001604	C_CLIP
ANT11003,ANT11006	3712-001604	C_CLIP
ANT11007,ANT11008	3712-001604	C_CLIP
ANT2010	3712-001604	C_CLIP
ANT11004,ANT11009	3712-001633	C_CLIP
ANT8007,ANT8008	3712-001633	C_CLIP

Confidential and proprietary-the contents in this service guide subject to change without prior notice

Distribution, transmission, or infringement of any content or data from this document without Samsung's written authorization is strictly prohibited.

5. MAIN Electrical Parts List

ANT4000,ANT4001	3712-001634	C_CLIP
ANT4002,ANT4003	3712-001634	C_CLIP
ANT4004,ANT4005	3712-001634	C_CLIP
ANT1001,ANT1002	3712-001666	C_CLIP
ANT1004,ANT2000	3712-001666	C_CLIP
ANT2001,ANT2002	3712-001666	C_CLIP
ANT2006,ANT2008	3712-001666	C_CLIP
ANT5000,ANT5003	3712-001666	C_CLIP
ANT5005,ANT9002	3712-001666	C_CLIP
ANT9003,U5027,U5028	3712-001666	C_CLIP
ANT8000,ANT8001	3712-001714	C_CLIP
ANT8002,ANT8003	3712-001714	C_CLIP
ANT8004,ANT8005	3712-001714	C_CLIP
ANT8006,ANT9000	3712-001714	C_CLIP
ANT9001	3712-001714	C_CLIP
ANT1003,ANT5001	3712-001731	C_CLIP
ANT5007	3712-001731	C_CLIP
IFC11000	3722-004150	CONNECTOR
F1000,F2005	4709-002196	RF MODULE
F5002,F5004	4709-002285	RF MODULE
U5007	4709-002708	RF MODULE
SUS3002,SUS3003	GH61-13928A	SUS
SUS3001	GH61-13929A	SUS
SUS3005	GH61-13930A	SUS
GA11000,GA11001	GH62-00042A	-
GA11002	GH62-00042A	-
SC3011	GH63-16566A	Shield Can
SC3002	GH63-16568A	Shield Can
SC3001	GH63-16569A	Shield Can
SC3008	GH63-16570A	Shield Can
SC3003	GH63-16571A	Shield Can
SC3006	GH63-16588A	Shield Can
SC3004	GH63-16624A	Shield Can
SC3007	GH63-16642A	Shield Can
SC3005	GH98-43745A	Shield Can
SC3006SP	GH02-17467A	TAPE
U5101SP	GH02-18195A	TAPE

Please consult the GSPN website (Samsung Portal) for the most recent version of the product's part list.

Confidential and proprietary-the contents in this service guide subject to change without prior notice

Distribution, transmission, or infringement of any content or data from this document without Samsung's written authorization is strictly prohibited.

6. Level 1 Repair

6-1. S/W Download

6-1-1. Prepare for S/W Downloading

- Installation program: Downloader Program ([Odin3 v3.13.3.exe](#))
- Mobile Phone
- Data Cable
- Mobile device specific S/W: Binary files

※ Settings



Data Cable :
GH39-01949A
GH39-01951A

6. Level 1 Repair

6-1-2. S/W Installation Program (Downloader program)

- Open up the S/W Installation Program by executing the "**Odin3 v3.13.3.exe**"

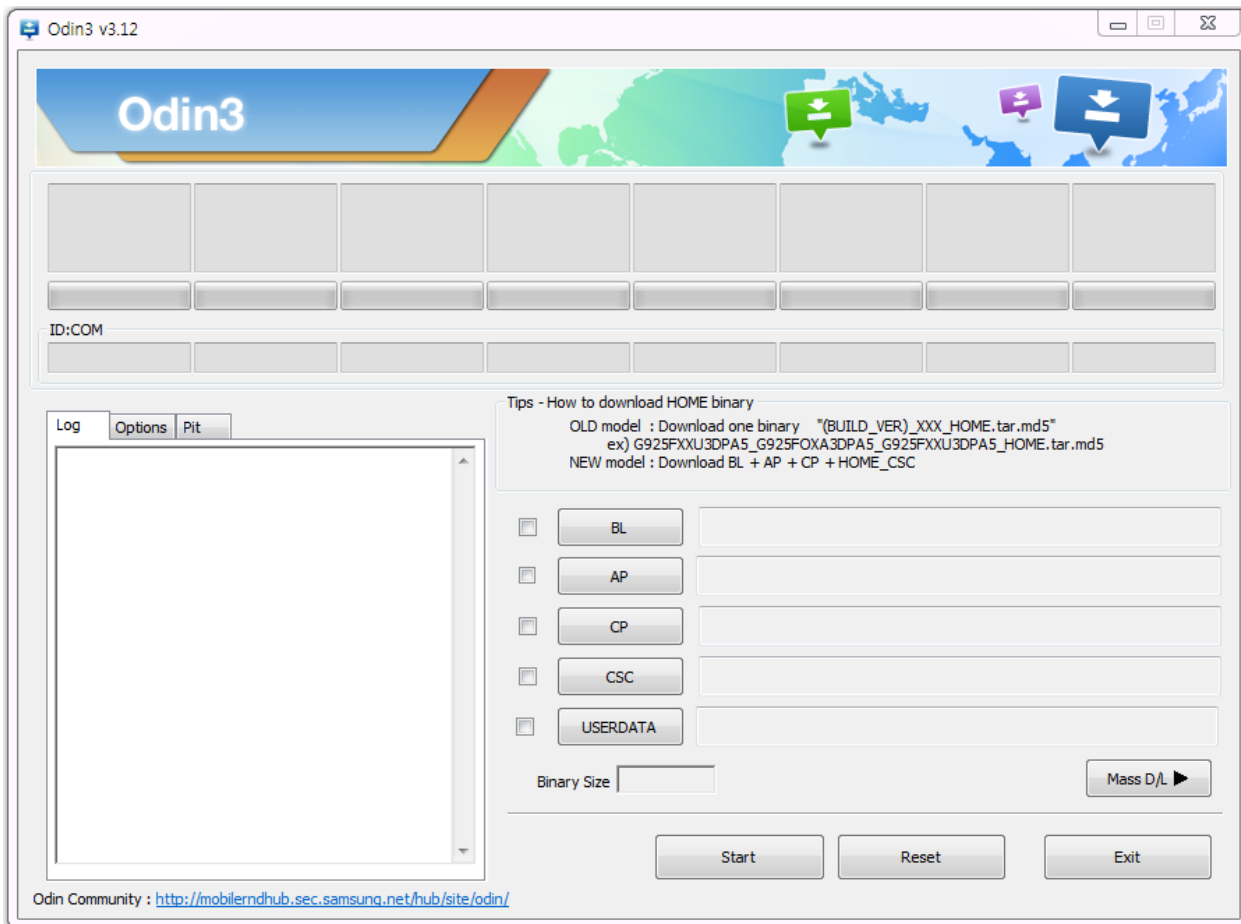

6. Level 1 Repair

1. Enable the check mark by click on the following options,

- Check Auto Reboot, F. Reset Time, Nand Erase
- Check PIT
- Check BOOTLOADER, PDA, PHONE, CSC and USERDATA Files

* Note : "Odin v3.13.2 or above" checks MD5 checksum just after file selection.

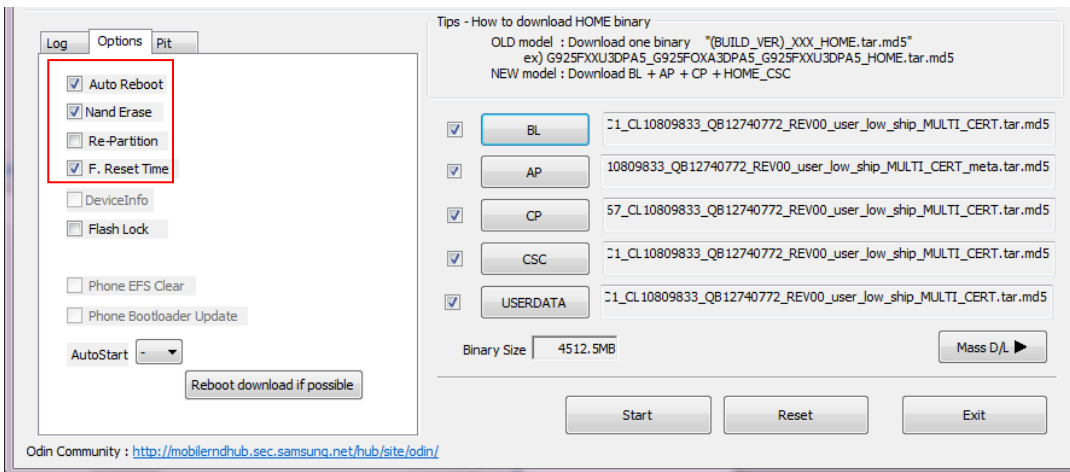
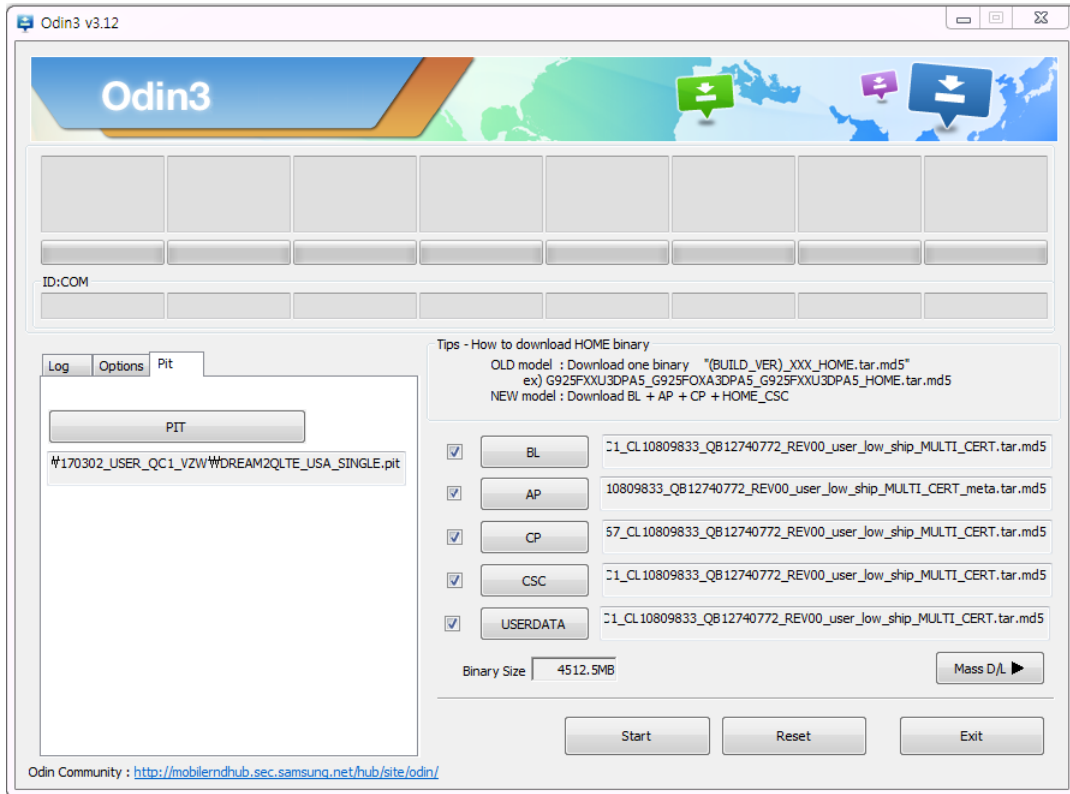

6. Level 1 Repair

2. Enter into Download Mode

- Enter into Download Mode by pressing Volume Down button and Intelligence button simultaneously and connecting data cable followed by pressing Volume up button as a direction of the phone.

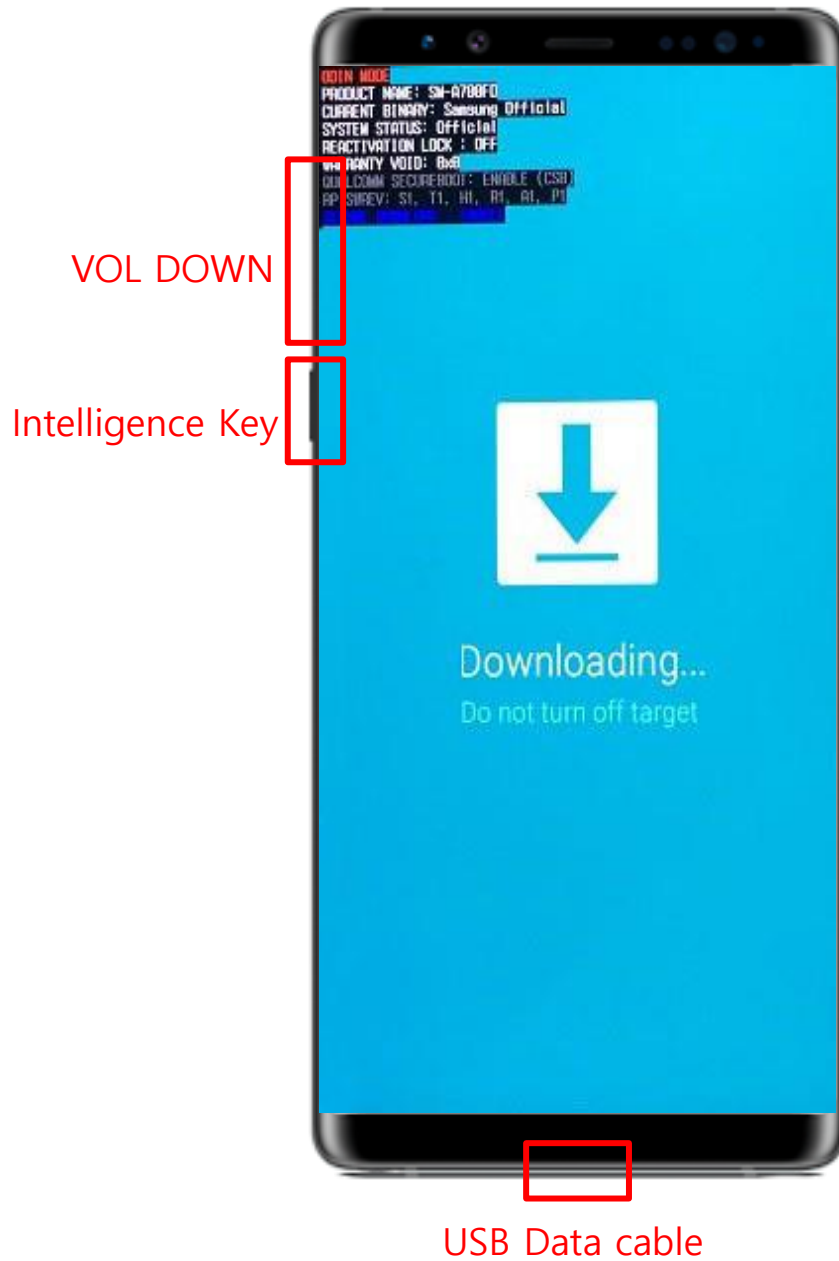

6. Level 1 Repair

3. Connect the device to PC via Data Cable.

Make sure that the one of communication ports [ID:COM] box is highlighted in sky blue.

The device is now connected with the PC and ready to download the binary files in it.

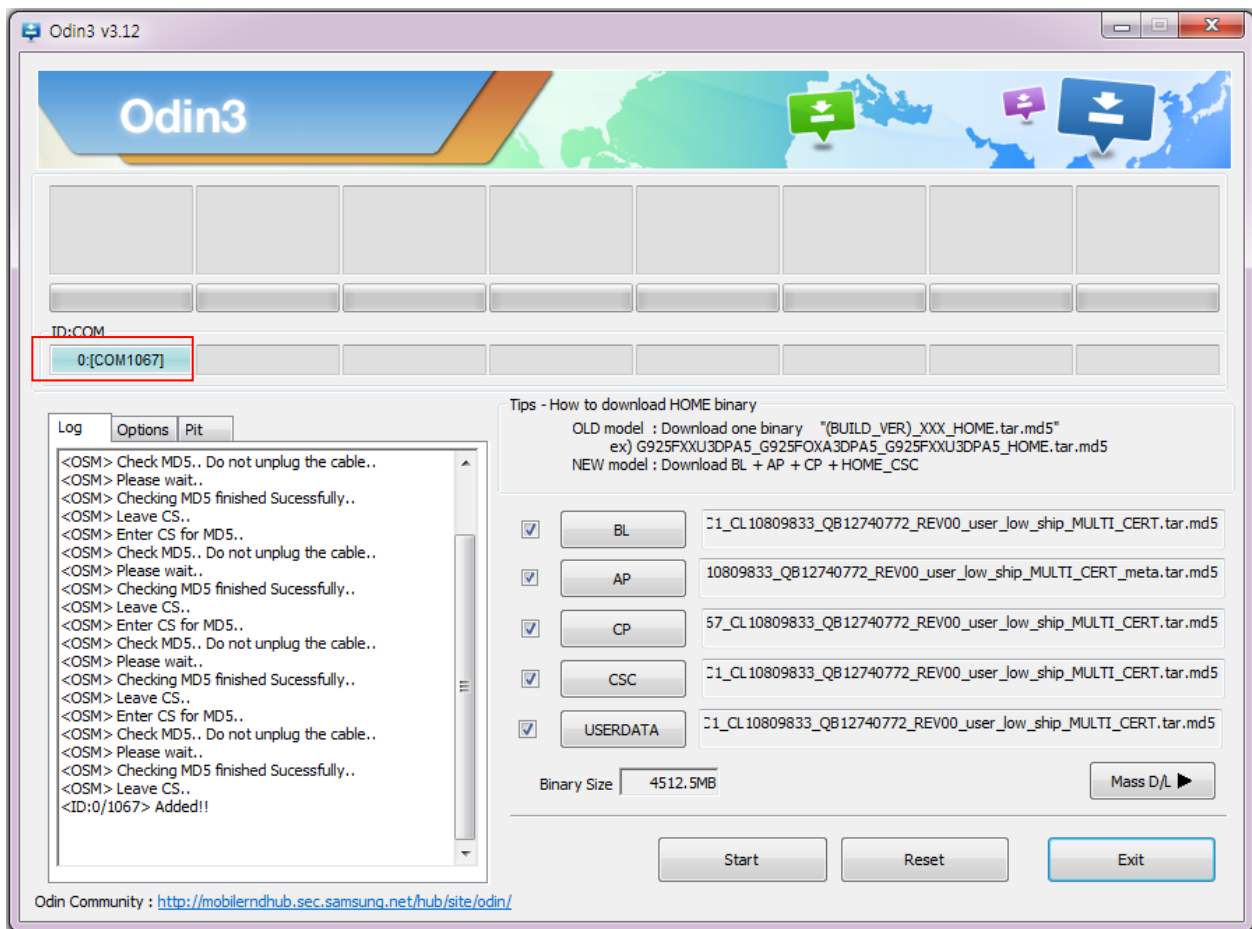

6. Level 1 Repair

4. Start downloading the binary files into the device by clicking Start button on the screen. The green colored "PASS!" sign will appear on the upper-left box if the binary files have been successfully downloaded into the device.

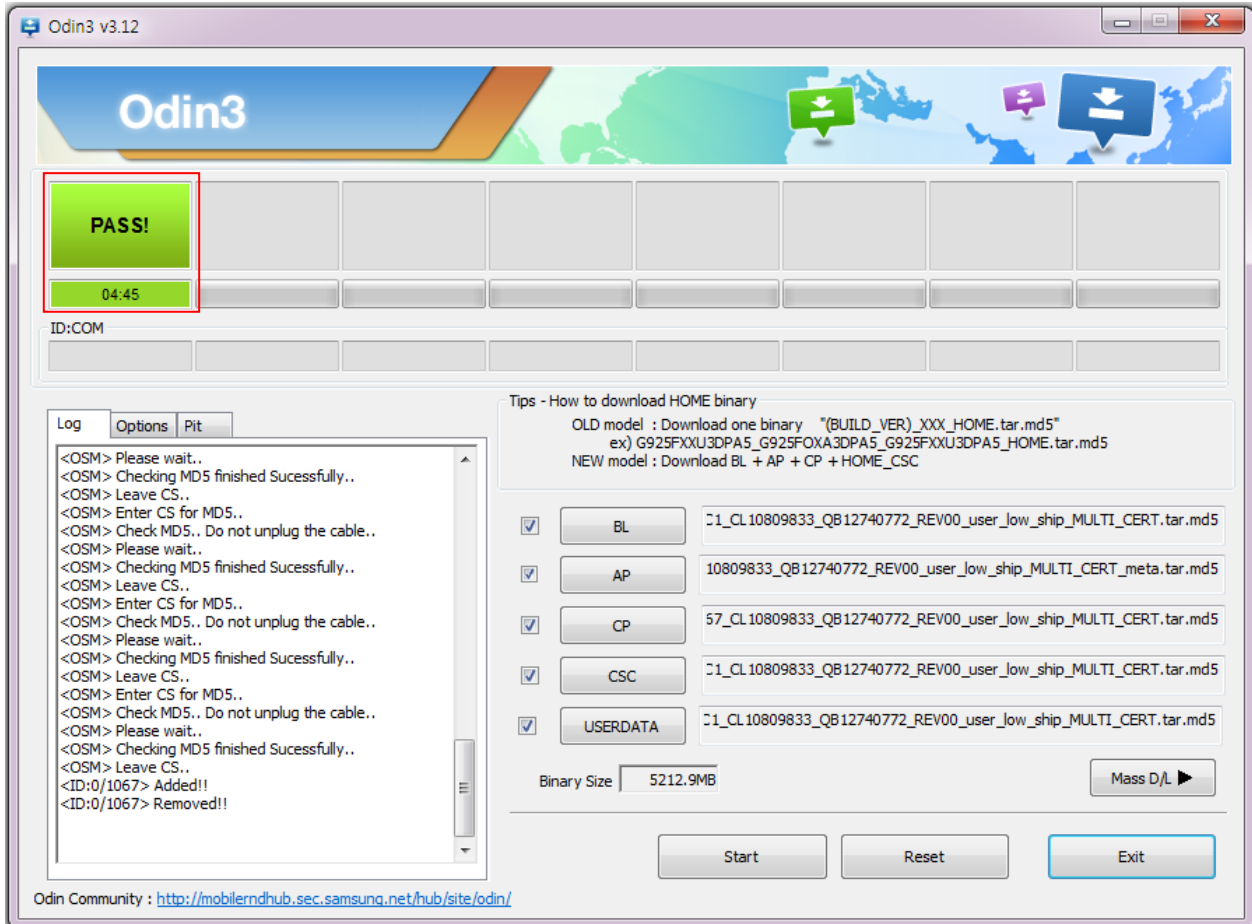

5. Disconnect the device from the Data cable.

6. Once the device boots up, you can check the version of the binary file or name by pressing the following code in sequence; ***#1234#**

You can perform Factory data Reset by Settings → General Management → Reset

※ Caution. Never disconnect during the S/W downloading.

6. Level 1 Repair

6-2 IMEI writing

6-2-1 Preparation

- New IMEI writing Program has been released.
- Supported Model : Models which CAB files are uploaded on HHPsvc INI File category, instead of ini file.
- Refer to below IMEI writing procedure.

- H/W

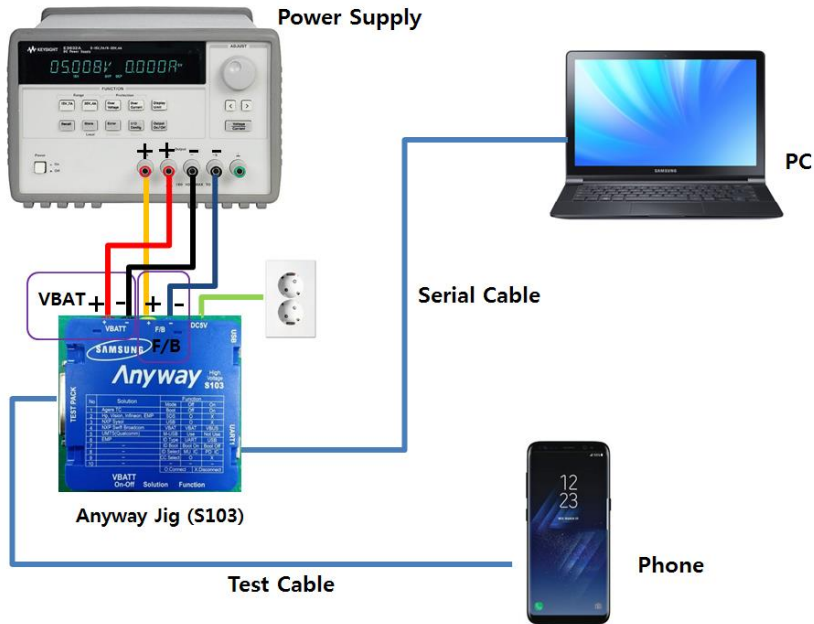

- S/W

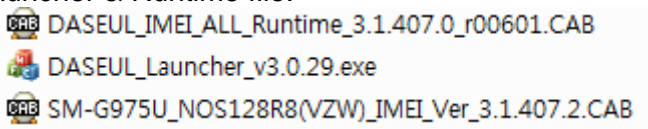
① Library Install	To use Daseul, library files should be installed. Refer to SVC Bulletin “(11-82) Daseul (New IMEI writing Program) Library Install guide_rev1.0”
② Launcher	DASEUL_SVC_Launcher_v3.0.29 or higher -Uploaded on HHPsvc Notice
③ Runtime File	1. DASEUL_IMEI_ALL_Runtime_3.1.407.0_r00601.CAB or higher -Uploaded on HHPsvc Notice 2. Make 'ModelName' folder at the same position with launcher & Runtime file. 
④ Model File	Copy Model File under the 'Model Name' folder

6. Level 1 Repair

6-2-2 IMEI writing Process

1. Run DASEUL_SVC_Launcher_v3.0.29.exe

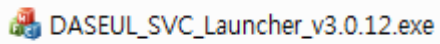

DASEUL_SVC_Launcher_v3.0.12.exe

2. Select Service Mode

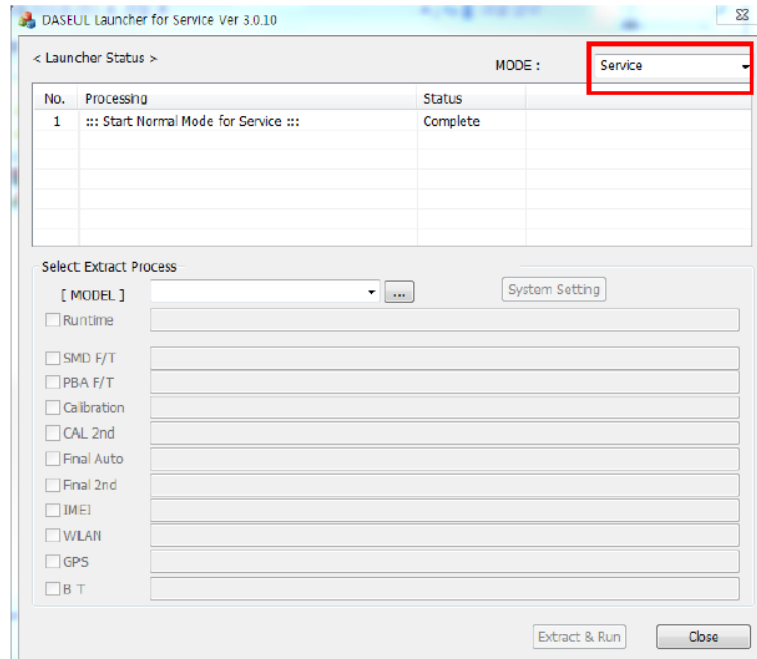

3. Click  and Select folder where the Launcher exists

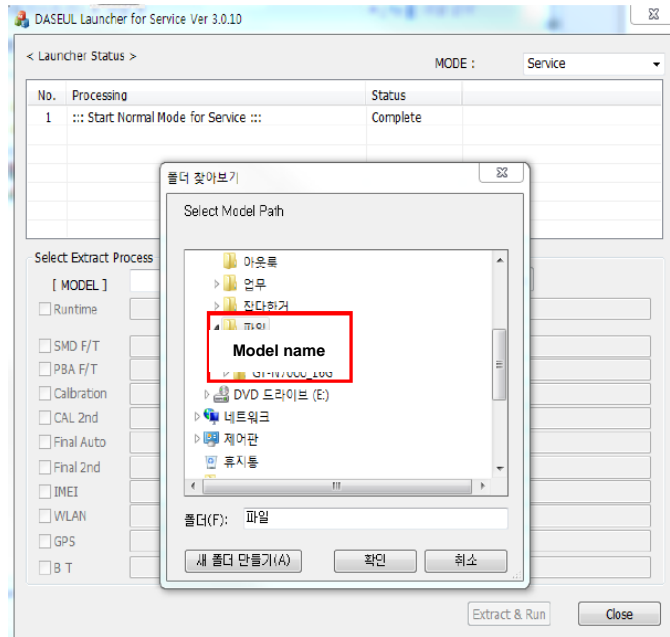

6. Level 1 Repair

4. Select Model

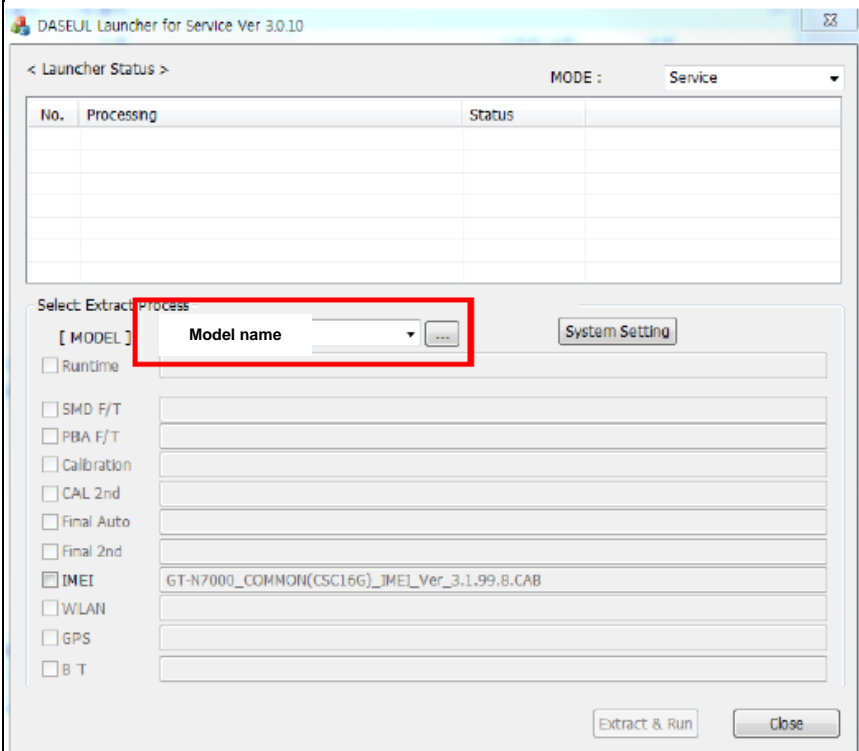

5. Check IMEI and click System Setting

※Once you setup the setting, you don't have to do it again, unless there is change.
From second run of the IMEI program, check IMEI and click Extract & Run.

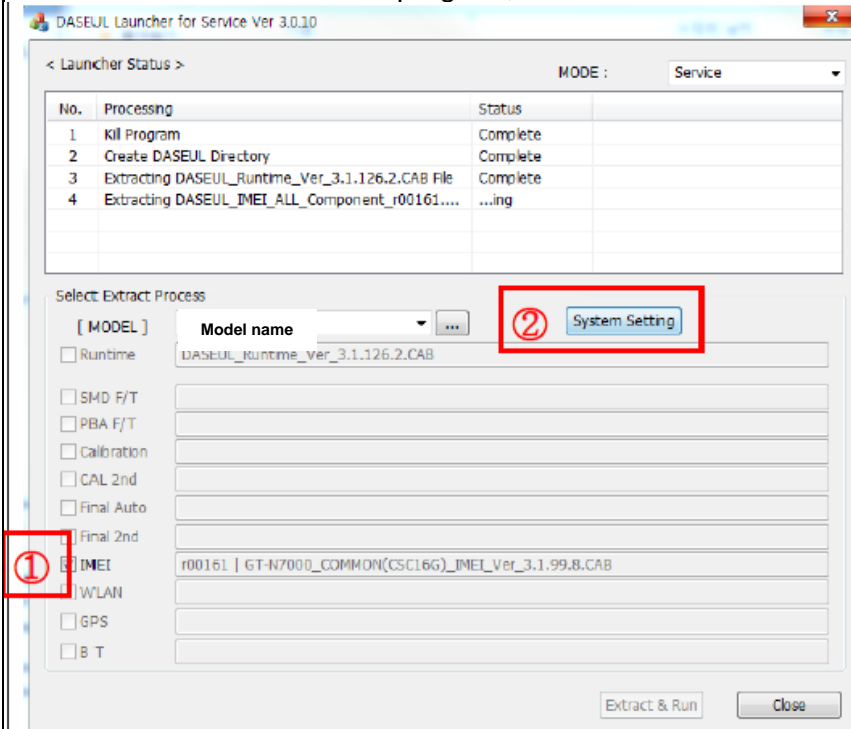

6. Level 1 Repair

6. Check IMEI Write / IMEI Check and click IMEI SVC & Repair Option.

Set System Configuration
Set System Configuration Dialog...

Test Process

[Process]	[Master]	[Slave]
SMD F/T	<input type="checkbox"/>	<input type="checkbox"/>
PBA F/T	<input type="checkbox"/>	<input type="checkbox"/>
Calibration	<input type="checkbox"/>	<input type="checkbox"/>
Calibration 2ND	<input type="checkbox"/>	<input type="checkbox"/>
Final Auto	<input type="checkbox"/>	<input type="checkbox"/>
Final Auto 2ND	<input type="checkbox"/>	<input type="checkbox"/>
Final Manual	<input type="checkbox"/>	<input type="checkbox"/>
IMEI Write	<input checked="" type="checkbox"/>	<input type="checkbox"/>
IMEI Check	<input checked="" type="checkbox"/>	<input type="checkbox"/>
MDL+2nd Check	<input type="checkbox"/>	<input type="checkbox"/>
MDL Rework	<input type="checkbox"/>	<input type="checkbox"/>
IMEI Read	<input type="checkbox"/>	<input type="checkbox"/>
STA Write	<input type="checkbox"/>	<input type="checkbox"/>
STA Check	<input type="checkbox"/>	<input type="checkbox"/>
STA Reset	<input type="checkbox"/>	<input type="checkbox"/>
WLAN	<input type="checkbox"/>	<input type="checkbox"/>
GPS	<input type="checkbox"/>	<input type="checkbox"/>
BT	<input type="checkbox"/>	<input type="checkbox"/>
WLAN	<input type="checkbox"/>	<input type="checkbox"/>
Power Off-On before WLAN	<input type="checkbox"/>	<input type="checkbox"/>
Bluetooth	<input type="checkbox"/>	<input type="checkbox"/>
LCIA	<input type="checkbox"/>	<input type="checkbox"/>
Merge 2G3G Block Rad.	<input type="checkbox"/>	<input type="checkbox"/>

Test Condition

Calibration
Real CAL Cycle: on every default CALs

Calibration Mode :

CAL2nd Mode :

Final
Supply RF Signal by :

Reset Loss Correction Count

Test Mode :

WLAN
Test Mode :

IMEI
Use RFSM
Use Second PC
Save ODS
Merge Felica Cal
OQC Reset
IBI Reset

System Config.

Language :

Line Name :

Line Type :

Smart Cloud Cell

of Phone :

Start Number of UI :

Start Number of Jig :

IP Address : 10.244.246.156

SKD Mode

MultiSharing(CMWS)

Developer Mode

Advanced Separating(ADS)

Operation Condition

7. Check 'SVC , User Ticket No' and click OK

IMEI SVC && Repair Option

FTR Rework Korean SVC

SVC SELA MIAMI Local FOTA Check

DEVELOPE Repair Board SVC Factory Reset

Romania SVC Argentina SKD

Initial PGM(SVC) Turkey

ATT Rework Slovakia SVC

IMEI Clear(Factory) GED 2nd Inspection

Outgoing Inspection Check SBSC(PBA) SVC

6. Level 1 Repair

8. Click 'Hardware Config'

Set System Configuration
Set System Configuration Dialog...

Test Process

[Process]	[Master]	[Slave]
SMD F/T	<input type="checkbox"/>	<input type="checkbox"/>
PBA F/T	<input type="checkbox"/>	<input type="checkbox"/>
Calibration	<input type="checkbox"/>	<input type="checkbox"/>
Final Auto	<input type="checkbox"/>	<input type="checkbox"/>
Final Manual	<input type="checkbox"/>	<input type="checkbox"/>

IMEI Process

IMEI Write	<input checked="" type="checkbox"/>	<input type="checkbox"/>
IMEI Check	<input checked="" type="checkbox"/>	<input type="checkbox"/>
MDL+2nd Check	<input type="checkbox"/>	<input type="checkbox"/>
MDL Rework	<input type="checkbox"/>	<input type="checkbox"/>
IMEI Read	<input type="checkbox"/>	<input type="checkbox"/>

WLAN
Power Off-On before WLAN
Bluetooth

Test Condition

Calibration
Real CAL Cycle: on every [20] default CALs
Calibration Mode: [Dynamic]

Final
Supply RF Signal by: [Conduction]

Test Signal Mode: [Signaling]

Developer Mode

IMEI

Use RFSM
Use Second PC
Save ODS

System Config.

Language: [English]
Line Name: [LINE(temp)]
Line Type: [Block Cell]
of Phone: [1]
Start Number of Jig: [1]
IP Address: [10.244.114.62]

Operation Condition

Model Information
Hardware Config
Signal Loss Config.
Channel Config.
MSTS Calibration
Setting End Band

IMEI SVC&Repair Option
Operation Condition
OK

9. Click 'Port Setting'

Hardware Component Configuration
Controller Type, IO Bus Type, Port Setting,...

Phone

Count: [1]
I/F - 1 Type: [Serial COM]
I/F - 2 Type: [N/A] **Port Setting**
IF Jig Type: [AnyWayJig]
 Use ID Check JIG

MSTS Sharing Controller

Count: [0]
Control Type: [N/A]
I/F Type: [Serial COM] **Terminal** **Port Setting**

Robot / ShieldBox

Control Type: [N/A]
I/F Type: [Serial COM] **Port Setting**

DBMS

Server: [HOME(GUMI)]
Type: [Outside-Socket]

Barcode Reader

Type: [N/A]
I/F Type: [Serial COM] **Port Setting**

MES PN Sender

Type: [N/A] **Port Setting**

PBA F/T

Function Test Jig **Port Setting**
NI-DAQ **Port Setting**
Power Detector **Port Setting**
HDMI JIG **Port Setting**

MSTS

Count: [0]
I/F Type: [GPIB] **Port Setting**

Power Supply

I/F Type: [GPIB] **Port Setting**

SMD F/T

Type: [N/A]
B'd Address: [5] **Port Setting**

SAVE
Cancel

6. Level 1 Repair

10. Select Port Number and SAVE

Set IO BUS Configuration

Phone IO Bus Setting

Common

BaudRate: 115200
Data Bit: 8
Parity: No
Stop Bit: 1

No.	Port #1
1	1

SAVE
Cancel

11. Click OK to proceed

Set System Configuration
Set System Configuration Dialog...

Test Process

[Process] [Master] [Slave]

SMD F/T
PBA F/T
Calibration
Final Auto
Final Manual

IMEI Process

IMEI Write
IMEI Check
MDL +2nd Check
MDL Rework
IMEI Read

WLAN
Power Off-On before WLAN
Bluetooth

Test Condition

Calibration
Real CAL Cycle: on every 20 default CALs
Calibration Mode: Dynamic
Final
Supply RF Signal by: Conduction
Test Signal Mode: Signaling
Developer Mode

IMEI
Use RFSM
Use Second PC
Save ODS

IMEI SVC&Repair Option

System Config.

Language: English
Line Name: LINE(temp)
Line Type: Block Cell
of Phone: 1
Start Number of Jig: 1
IP Address: 10.244.114.62

Operation Condition

Operation Condition

Model Information
Hardware Config
Smart Loss Config
General Config
WPS Calibration
Setting End Band

OK

6. Level 1 Repair

12. Click Model Info and OK when pop-up shows

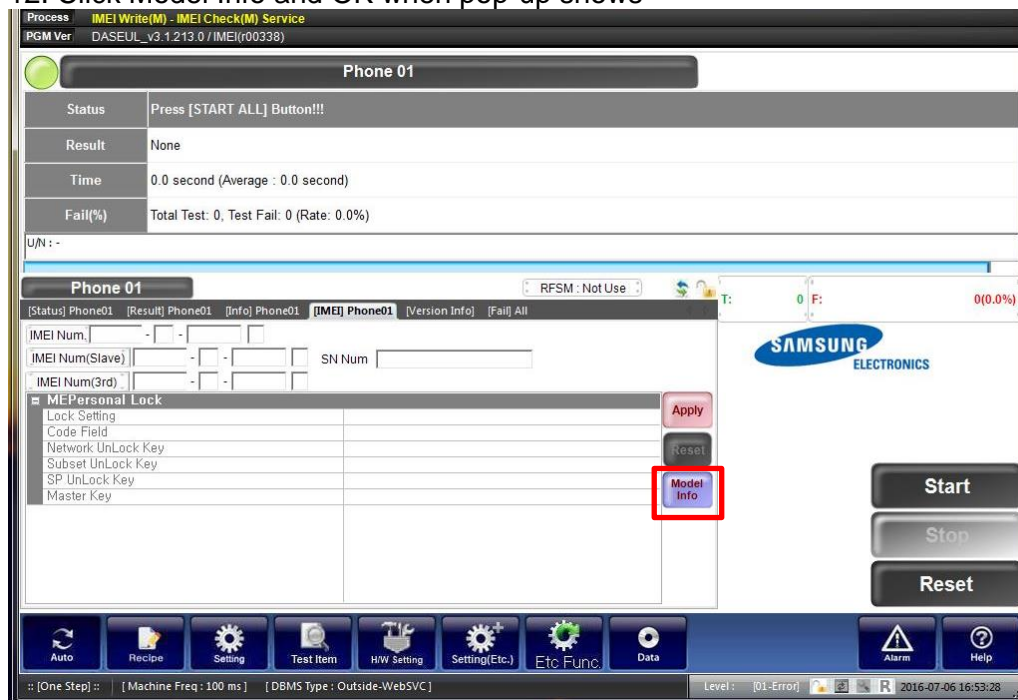

13. Click OK



6. Level 1 Repair

14. Input SKU_CODE and BUYER, then click Save button.

※ Refer to HHPsvc→IMEI Review to check SKU Code and buyer

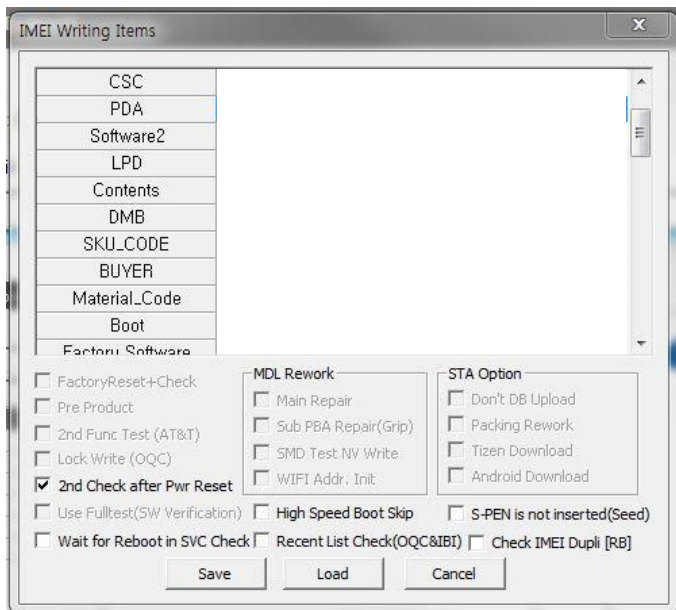

15. Input IMEI Number and click Apply

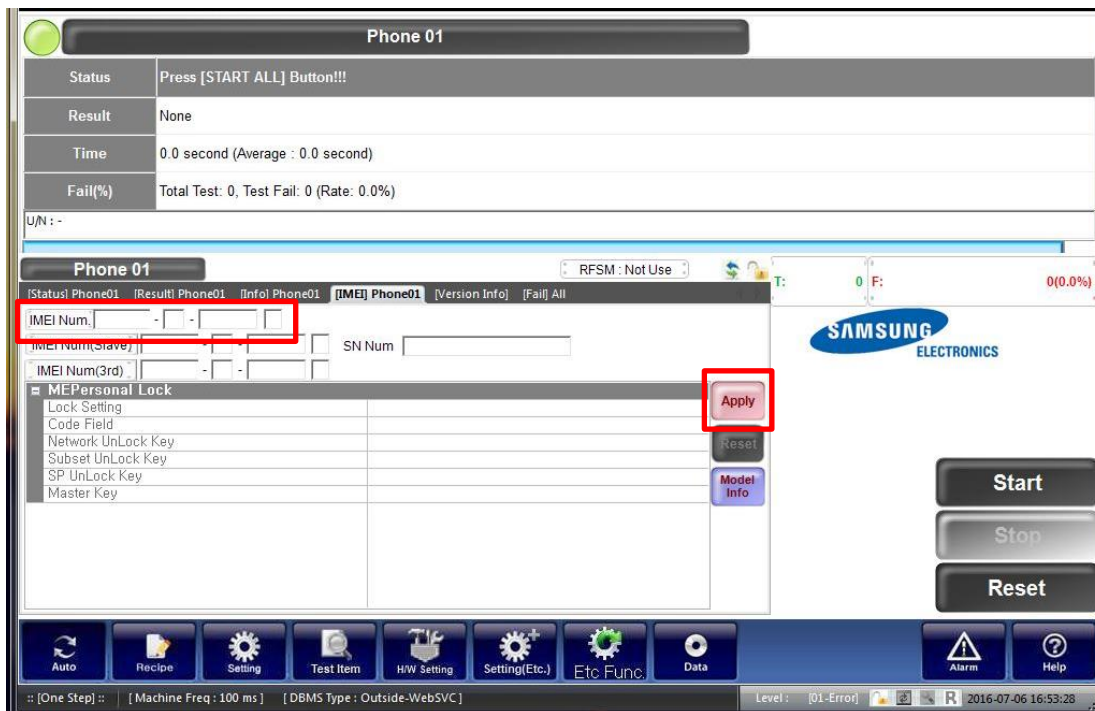

6. Level 1 Repair

16. ① Click Start → ② Input IMEI writing ID and Password & OTP → ③ Input Ticket No

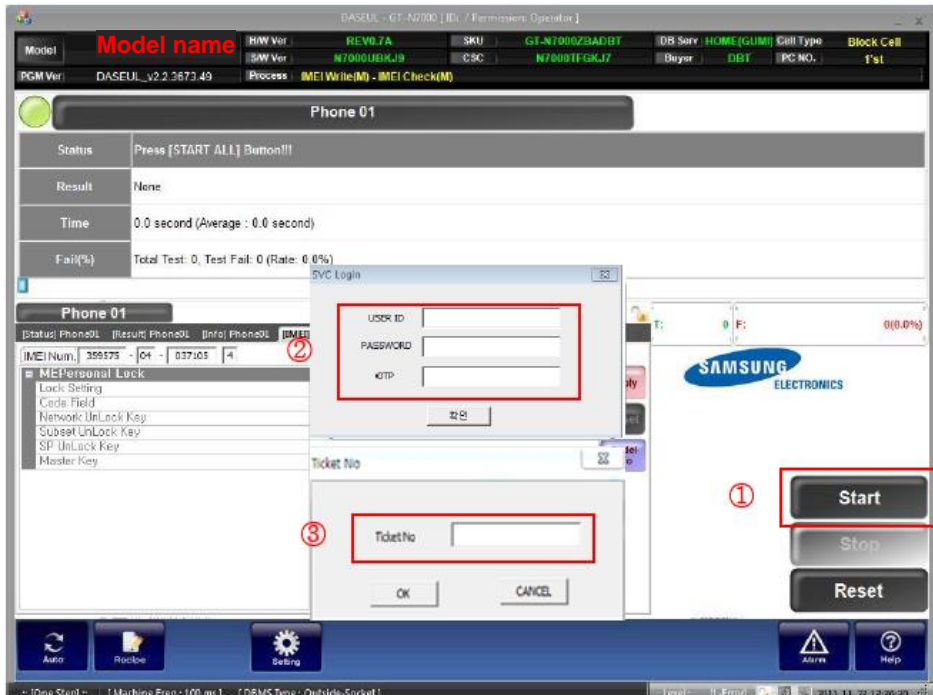

※ OTP(One time Password) : OTP is valid for 6 hours.

After that, you can get new OTP by click the “Forgotten your IMEI OTP PW or Create new IMEI OTP PW” button.

☞ OTP Location : GSPN → Knowledge → HHP svc → Home

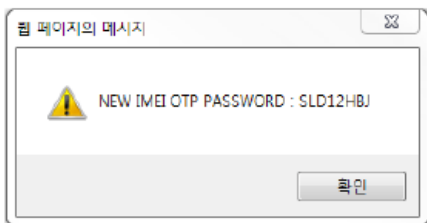
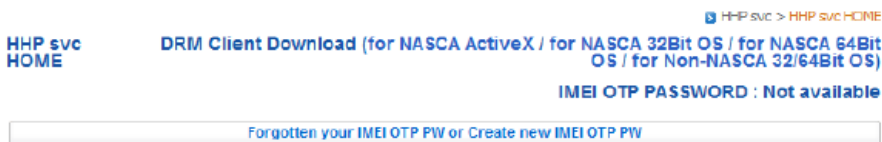

6. Level 1 Repair

17. Connect the phone to Anyway JIG

- ✳ When you connect the phone, the phone should be turned off.
After connecting the phone, the phone will be booted automatically.

18. IMEI Writing Proceeding

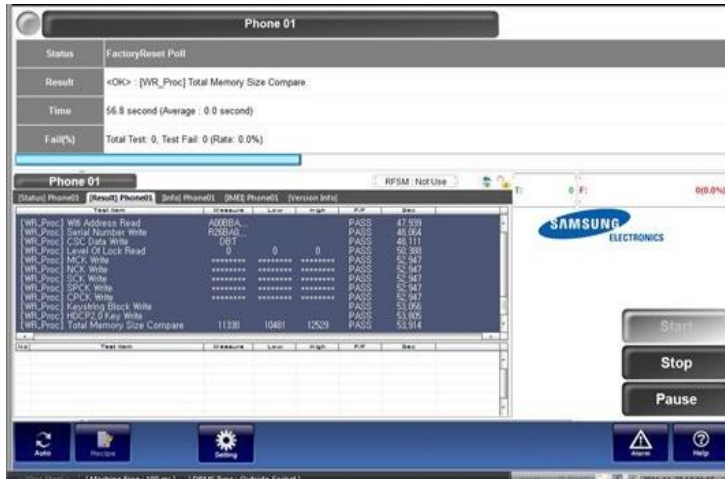

19. IMEI Writing Success

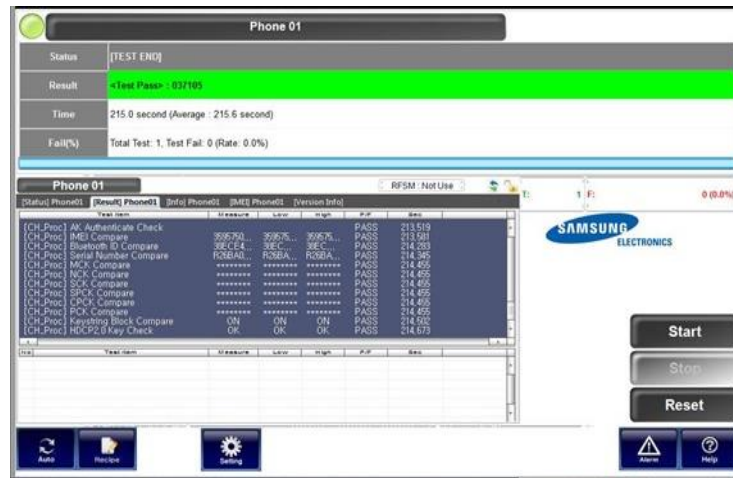

7. Level 2 Repair

7-1. Components on the Rear Case



7. Level 2 Repair

7-2. Pre-requisite

	
Tweezers / Disass'y Stick / Screw Driver	Anti-static Gloves
	
Anti-static Mat	Hot Plate
	
A OCTA Disassembly Holder	OCTA Disassembly Upper
	
Ethyl Alcohol	Cotton Swab

7. Level 2 Repair

7-3. Parts which must be changed after repair

BOM description & part code	KIT CODE	Image	Remarks
<p>A/S-SVC BACKGLASS OUTSIDE TAPE</p> <p>[GH81-16446A]</p>	<p>[GH82-18800A]</p>		<p>Replace for Back Glass</p>
<p>A/S-SVC CAM SEALING TAPE (Common)</p> <p>[GH02-17475A]</p>			
<p>Mic sealing tape</p> <p>[GH02-07406A]</p>			
<p>3 screws for PBA</p> <p>[6001-003360]</p>		<p>※ 3 Screws on the PBA cannot be reused, replace the new 3 screws after removing the 3 screws.</p>	

7. Level 2 Repair

7-4. Disassembly

1

Put the device in the chamber as following below heating condition
 - SOC 68%↓: 70°C/10~20 minute
 - SOC 68%↑: 60°C/10~20 minute
 ※ Please confirm the heating condition released lastly, and follow it.



2

Detach the Back Glass.
 Detach the left side of Back glass

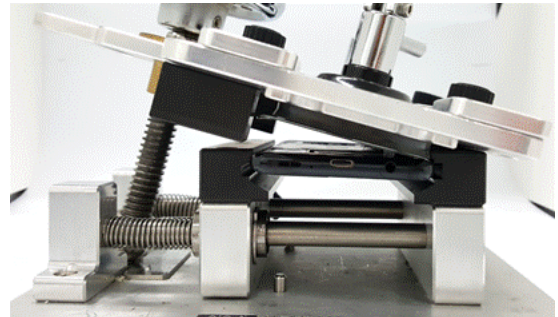

※ Caution
 Be care of scratch.

※ Caution
 Be care of scratch.

3

Unscrew 15 Point and disassemble SIM Tray from device.



4

Disassemble Upper Rear.
 (Use disassemble hole left/right side of Rear to detach it)

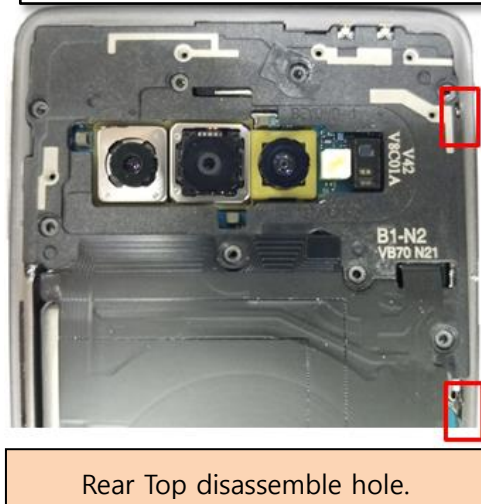

※ Caution
 Be care of Rear damage.

※ Caution
 1) Be care of scratch.
 2) Be care of Rear and connector damage.
 3) Be care of NFC ANT damage.

7. Level 2 Repair

5

Finally Disassemble Rear of bottom side.
(Use disassemble hole right side of Rear to detach it)



6

Unscrew PBA 3points.



※ Caution

- 1) Be care of scratch.
- 2) Be care of Rear and connector damage.
- 3) Be careful not to damage the PBA.

※ Caution

- 1) Be careful not to damage the PBA.
- 2) 3 Screws on the PBA cannot be reused, replace the new 3 screws after removing the 3 screws.

7

Detach Battery connect and the other connectors. (4 Point)



8

Disassemble the PBA.

- 1) Lift the PBA using the right disassembly hole.
- 2) Separate the PBA from the top.

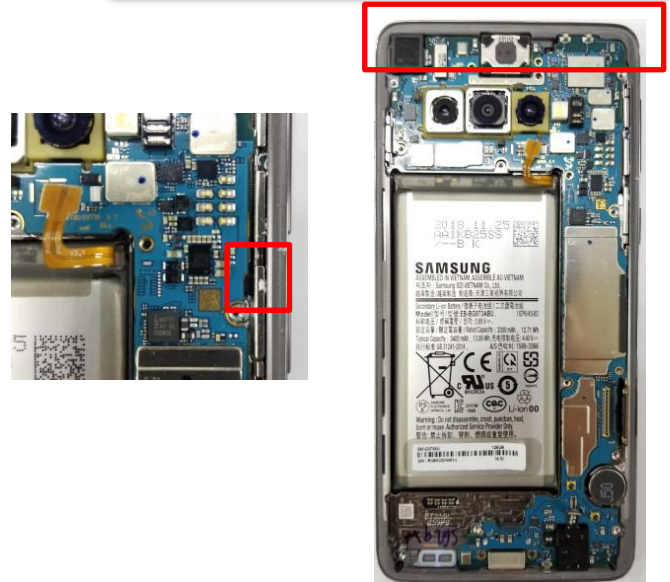

※ Caution

- 1) Be care of scratch.
- 2) Be care of connector damage.

※ Caution

Be care of several kinds of damage

7. Level 2 Repair

9

Disassemble SUB Camera.
Disassemble Main Camera.

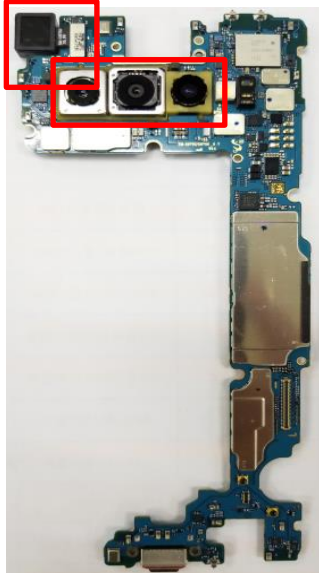

10

Disassemble the Ear jack
Separate the Ear jack using the Ear jack disassembly hole.



※ Caution

Be careful not to damage the CAM.

※ Caution

Be care of Ear jack connector FPCB damage.

11

Detach other components.
Put the device in the chamber as following
below heating condition.
- 70°C±5°C, 10 minutes



※ Caution

Be care of scratch.

Confidential and proprietary-the contents in this service guide subject to change without prior notice

Distribution, transmission, or infringement of any content or data from this document without Samsung's written authorization is strictly prohibited.

7. Level 2 Repair

7-5. Assembly

1

Assemble the Main Cam.
Assemble each of Main Camera Connector
2 Points based on the PBA Connector.

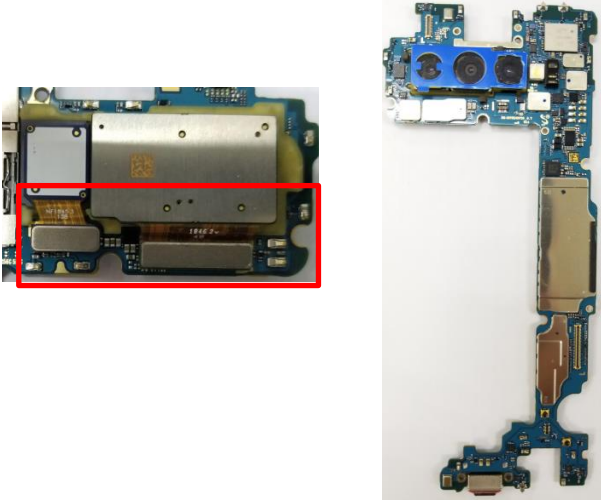

2

Attach components on Front.
(RCV, Motor)



※ Caution

- 1) Assemble it without Connector mold crushed
- 2) Check MAIN CAMERA connector (insertion/no insertion)

※ Caution

Be care of chip damage nearby screw point.

3

Assemble the PBA into the front.
1) Temporarily place PB's USB/bottom, right
C-CILP by putting them diagonally into the
Front, and place them by pressing the back
of USB terminal.
2) Check USB's left/right Holes match Boss
Tap Hole
3) Connect the battery connector and the UB
connector.

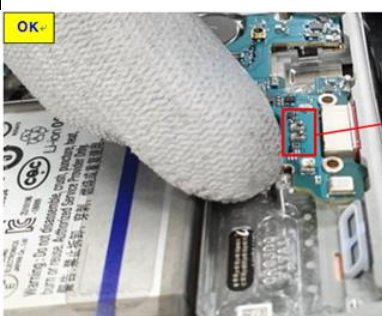

4

Assemble the Earjack.
1) Insert the Earjack diagonally.
2) Insert so that there is a clap.
3) Connect the Earjack connector.

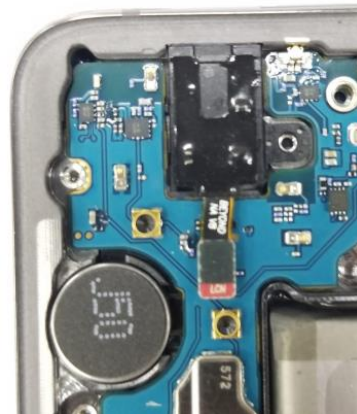

※ Caution

- 1) When assembling the PBA to the front, Be careful not to touch IF bottom chip.
- 2) Be careful that C-CLIP located on the top is not damaged.

※ Caution

Be careful of damage of Connector.

7. Level 2 Repair

5

Connect the SUB camera.
 1) place the body tube and then assemble Connector to PBA.
 2) When Connector is assembled without PBA fixed to Front Assy, Connector could be crushed/damaged



6

Use a manual assembler to assemble the screw at the PBA 3 point.
 ※ Torque Value : 1.3kgf±7% (1.2~1.4, 3M Patch)



※ **Caution**
 When assembling Connector, be careful of cracks of chip around.

※ **Caution**
 1) Be care of scratch and REAR damage
 2) Check for contact damage.(red area)

7

Assemble REAR BTM(SPEAKER)'s bottom
 1) Place REAR BTM's bottom at an angle to assemble HOOK
 2) Assemble left HOOK(SPK SUS's left)
 3) Assemble right Hook.

8

Assemble REAR Top. Place(at an angle) and assemble REAR TOP's top Hook (Gently)
 1) Assemble REAR TOP's left Hook.
 2) Assemble REAR TOP's right Hook.

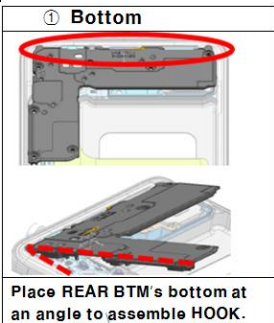

Place REAR BTM's bottom at an angle to assemble HOOK.

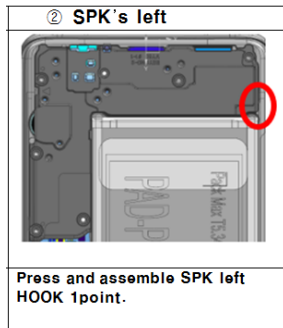

Press and assemble SPK left HOOK 1point.

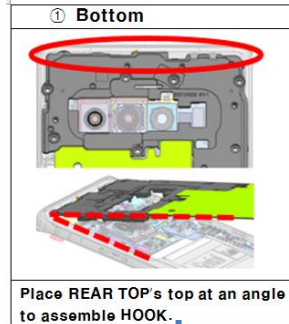

Place REAR TOP's top at an angle to assemble HOOK.

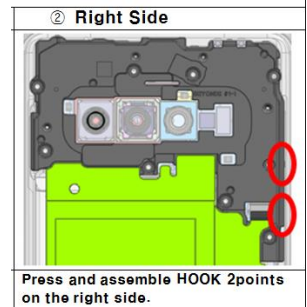

Press and assemble HOOK 2points on the right side.

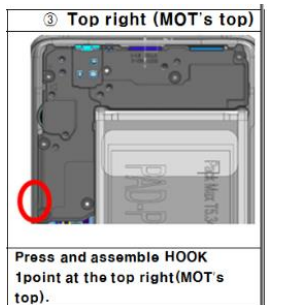

Press and assemble HOOK 1point at the top right(MOT's top).



※ **Caution**
 1) When placing SPK, be careful of Hook's falling out. Check if Hook comes off after assembling Hook.
 2) Don't forcefully assemble Hook when it came off (could damage Hook).
 3) During SPEAKER's assembly, no Battery crush, dent, scratches.

※ **Caution**
 1) Don't assemble HOOK forcefully with HOOK not inserted! HOOK break, crush can happen)
 2) When assembling REAR ASSY, no crush, dent, scratches on Battery.

7. Level 2 Repair

9

Screw 15 Point and disassemble SIM Tray from device.

※Torque Value : 1.3kgf±7%



10

Remove B/G Mega, B/G Tape's release paper from the back of Backglass



※ Caution

Be care of Rear damage.

※ Caution

After removing release paper, no defect like Tape tilt/jamming

11

Attach the backglass.



※ Caution

Be care of scratch and tilt.

12

Press Back Glass.

Pressing force : 1N

Pressing time : 60 seconds

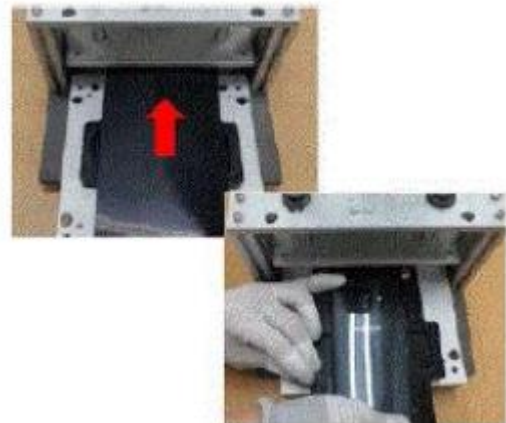

※ Caution

Be care of scratch.

8. Level 3 Repair

8-1. Components Layout

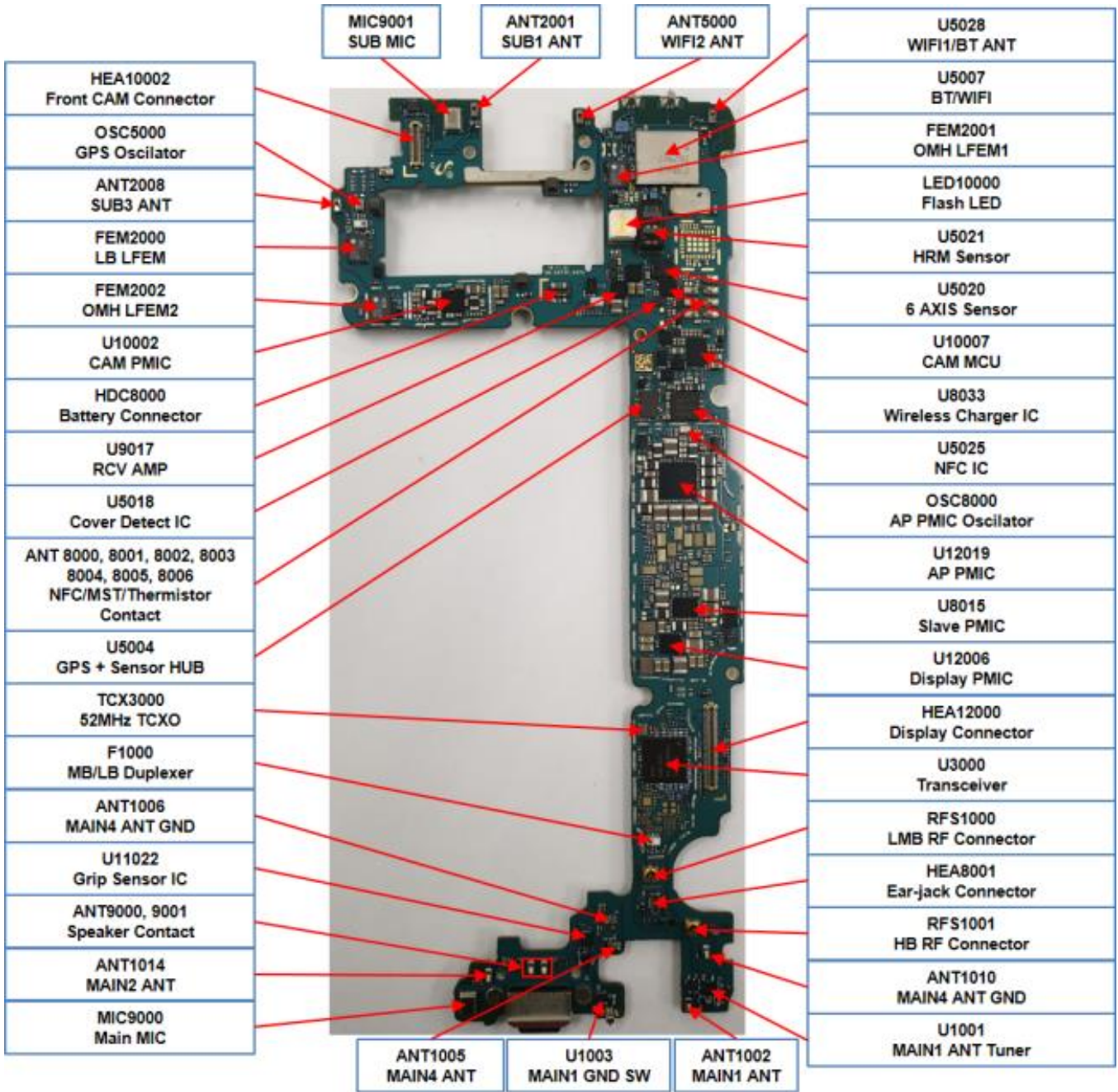

8. Level 3 Repair

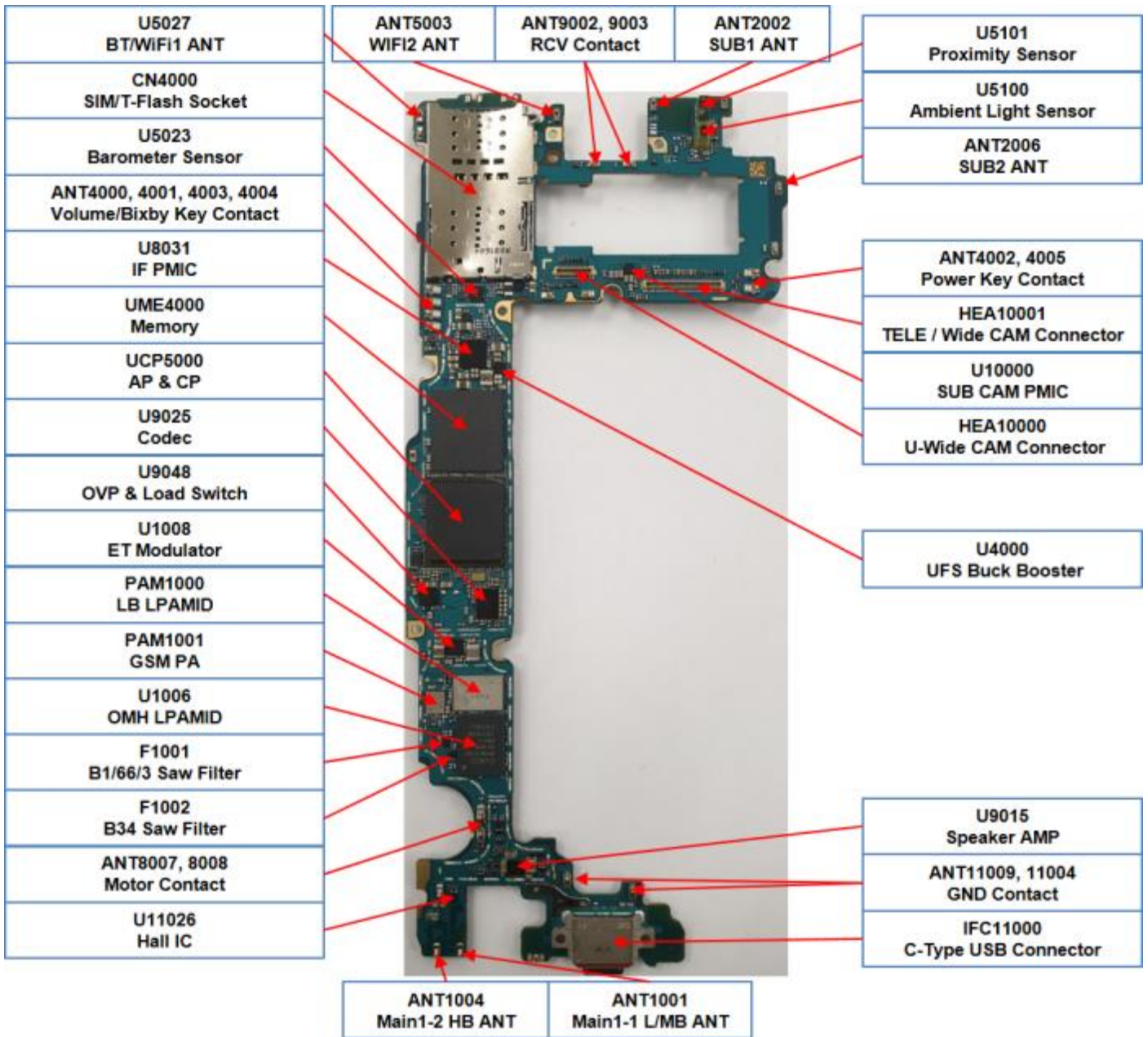

Confidential and proprietary-the contents in this service guide subject to change without prior notice

Distribution, transmission, or infringement of any content or data from this document without Samsung's written authorization is strictly prohibited.

SM-G973F/DS REV0.3

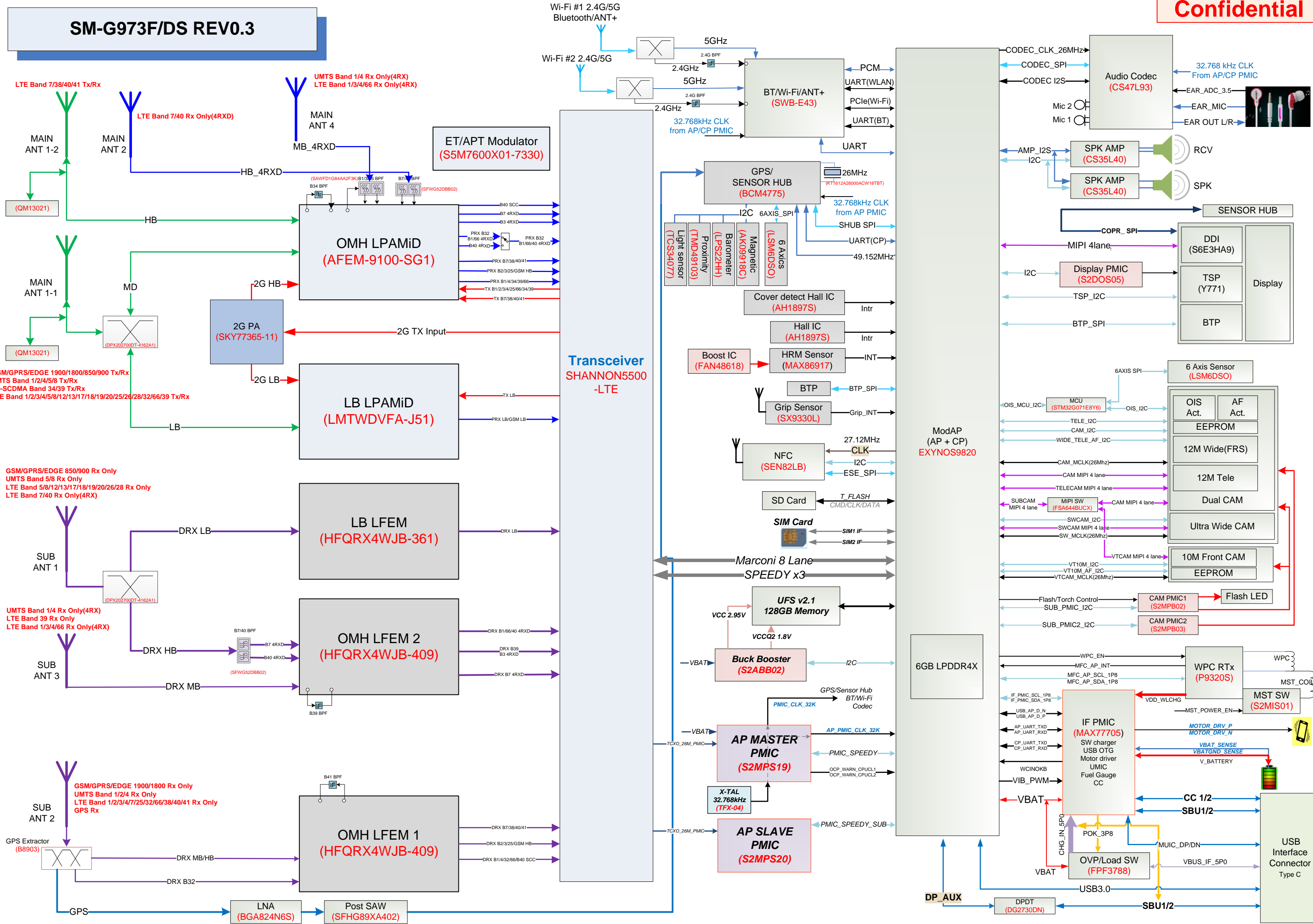

LTE Band 7/38/40/41 Tx/Rx
 MAIN ANT 1-2
 MAIN ANT 2
 LTE Band 7/40 Rx Only(4RXD)
 MB_4RXD
 HB_4RXD
 (QM13021)

UMTS Band 1/4 Rx Only(4RX)
 LTE Band 1/3/4/66 Rx Only(4RX)
 MAIN ANT 4
 (QM13021)

GSM/GPRS/EDGE 1900/1800/850/900 Tx/Rx
 UMTS Band 1/2/4/5/8 Tx/Rx
 TD-SCDMA Band 34/39 Tx/Rx
 LTE Band 1/2/3/4/5/8/12/13/17/18/19/20/25/26/28/32/66/39 Tx/Rx
 MAIN ANT 1-1
 MD
 (QM13021)

GSM/GPRS/EDGE 850/900 Rx Only
 UMTS Band 5/8 Rx Only
 LTE Band 5/8/12/13/17/18/19/20/26/28 Rx Only
 LTE Band 7/40 Rx Only(4RX)
 SUB ANT 1
 DRX LB
 (DPX202700DT-1162A1)

UMTS Band 1/4 Rx Only(4RX)
 LTE Band 39 Rx Only
 LTE Band 1/3/4/66 Rx Only(4RX)
 SUB ANT 3
 DRX HB
 DRX MB
 (SFWG52DBB02)

GSM/GPRS/EDGE 1900/1800 Rx Only
 UMTS Band 1/2/4 Rx Only
 LTE Band 1/2/3/4/7/25/32/66/38/40/41 Rx Only
 GPS Rx
 SUB ANT 2
 GPS Extractor (B8903)
 DRX MB/HB
 DRX B32

2G PA (SKY77365-11)
 2G TX Input
 2G HB
 2G LB
 LB LPAMiD (LMTWVFA-J51)
 TX LB
 PRX LB/GSM LB

LB LFEM (HFQRX4WJB-361)
 DRX LB

OMH LFEM 2 (HFQRX4WJB-409)
 DRX B1/66/40 4RXD
 DRX B39 B3 4RXD
 DRX B7 4RXD

OMH LFEM 1 (HFQRX4WJB-409)
 DRX B7/38/40/41
 DRX B2/3/25/GSM HB
 DRX B1/4/32/66/B40 SCC

LNA (BGA824N6S)
 Post SAW (SFHG89XA402)

Wi-Fi #1 2.4G/5G
 Bluetooth/ANT+
 5GHz
 2.4GHz
 2.4G BPF
 BT/Wi-Fi/ANT+ (SWB-E43)
 PCM
 UART(WLAN)
 PCIe(Wi-Fi)
 UART(BT)
 UART

ET/APT Modulator (S5M7600X01-7330)
 B40 SCC
 B7 4RXD
 B3 4RXD
 PRX B32 B1/66 4RXD
 B40 4RXD
 PRX B7/38/40/41
 PRX B2/3/25/GSM HB
 PRX B1/4/34/39/66
 TX B1/2/3/4/25/66/34/39
 TX B7/38/40/41

GPS/SENSOR HUB (BCM4775)
 26MHz
 32.768kHz CLK from AP PMIC
 SHUB SPI
 UART(CP)
 49.152MHz
 6 AXIS SPI
 Light sensor (TCS34077)
 Proximity (TMD49103)
 Barometer (LPS22HH)
 Magnetic (AK09918C)
 6 Axis (LSM6DSO)

Cover detect Hall IC (AH1897S)
 Hall IC (AH1897S)
 Boost IC (FAN48618)
 HRM Sensor (MAX86917)
 BTP
 Grip Sensor (SX9330L)
 NFC (SEN82LB)
 27.12MHz CLK
 I2C
 ESE_SPI
 SD Card
 T_FLASH
 CMD/CLK/DATA
 SIM Card
 SIM1 IF
 SIM2 IF

Marconi 8 Lane
 SPEEDY x3
 UFS v2.1 128GB Memory
 VCC 2.95V
 VCCQ2 1.8V
 Buck Booster (S2ABB02)
 I2C
 AP MASTER PMIC (S2MPS19)
 AP PMIC CLK 32K
 PMIC_SPEEDY
 OCP_WARN_CPUCL1
 OCP_WARN_CPUCL2
 X-TAL 32.768kHz (TFX-04)
 AP SLAVE PMIC (S2MPS20)
 PMIC_SPEEDY_SUB

ModAP (AP + CP) EXYNOS9820
 CODEC_CLK_26MHz
 CODEC_SPI
 CODEC_I2S
 Mic 2
 Mic 1
 Audio Codec (CS47L93)
 32.768 kHz CLK From AP/CP PMIC
 EAR_ADC_3.5
 EAR_MIC
 EAR OUT L/R
 SPK AMP (CS35L40)
 AMP_I2S
 I2C
 SPK AMP (CS35L40)
 RCV
 SPK
 SENSOR HUB
 COPR_SPI
 MIPI 4lane
 I2C
 Display PMIC (S2DOS05)
 TSP_I2C
 BTP_SPI
 DDI (S6E3HA9)
 TSP (Y771)
 Display
 BTP
 6 Axis Sensor (LSM6DSO)
 OIS Act.
 AF Act.
 EEPROM
 12M Wide(FRS)
 12M Tele
 Dual CAM
 Ultra Wide CAM
 10M Front CAM
 EEPROM
 OIS_MCU_I2C (STM32G071E8Y6)
 OIS_I2C
 TELE_I2C
 CAM_I2C
 WIDE_TELE_AF_I2C
 CAM_MCLK(26Mhz)
 CAM MIPI 4 lane
 TELECAM MIPI 4 lane
 SUBCAM MIPI 4 lane
 MIPI SW (FSA644BUCK)
 CAM MIPI 4 lane
 SWCAM_I2C
 SWCAM MIPI 4 lane
 SW_MCLK(26Mhz)
 VTCAM MIPI 4 lane
 VT10M_I2C
 VT10M_AF_I2C
 VTCAM_MCLK(26Mhz)
 Flash/Torch Control
 SUB_PMIC_I2C
 CAM PMIC1 (S2MPB02)
 Flash LED
 SUB_PMIC2_I2C
 CAM PMIC2 (S2MPB03)
 WPC_EN
 MFC_AP_INT
 MFC_AP_SCL_1P8
 MFC_AP_SDA_1P8
 WPC RTx (P9320S)
 WPC
 MST_COIL
 MST SW (S2MIS01)
 VDD_WLCHG
 MST_POWER_EN
 MOTOR_DRV_P
 MOTOR_DRV_N
 VBAT_SENSE
 VBATGND_SENSE
 V_BATTERY
 IF PMIC (MAX77705)
 SW charger
 USB OTG
 Motor driver
 UMIC
 Fuel Gauge
 CC
 CC 1/2
 SBU1/2
 VBAT
 CHG_IN_5P0
 POK_3P8
 MUIC_DP/DN
 VBUS_IF_5P0
 OVP/Load SW (FPF3788)
 USB3.0
 DP_AUX
 DPDT (DG2730DN)
 SBU1/2
 USB Interface Connector Type C

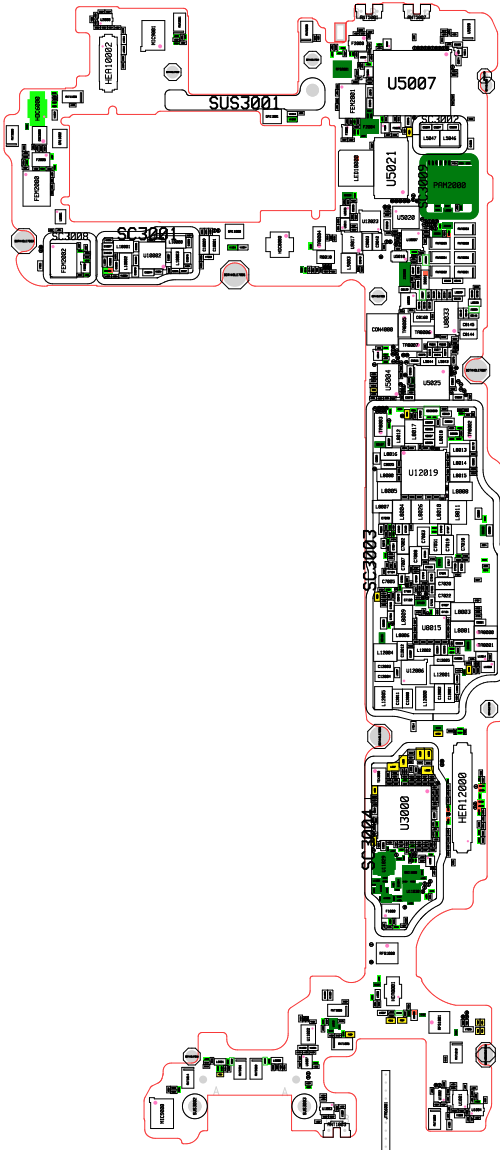

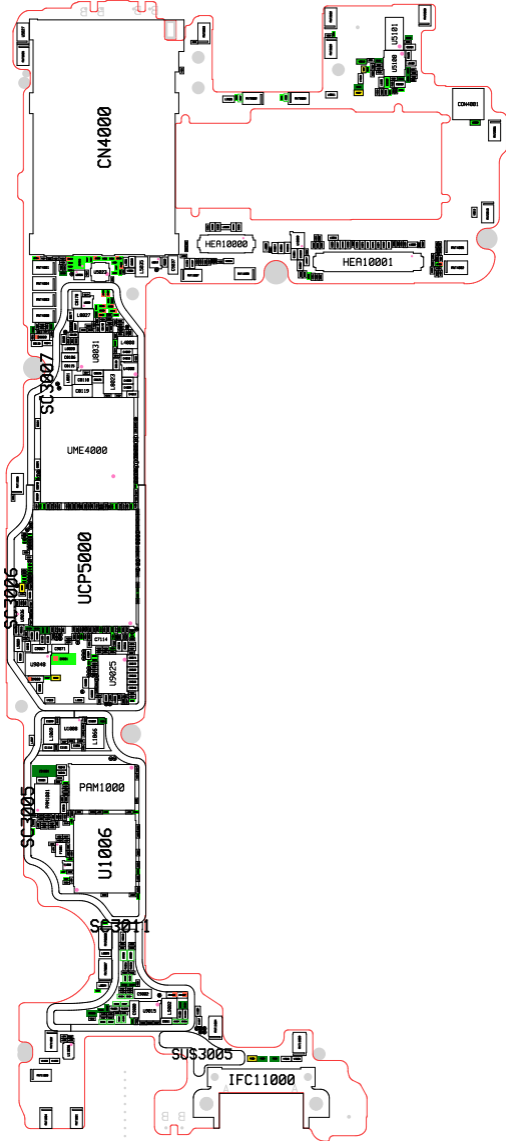

CN4000

COM4001

HEA10000

HEA10001

UME4000

UCP5000

PAM1000

U1006

IFC11000

SUS3005

SC3007

SC3006

SC3005

SC3011

8. Level 3 Repair

8-4-1. Power on

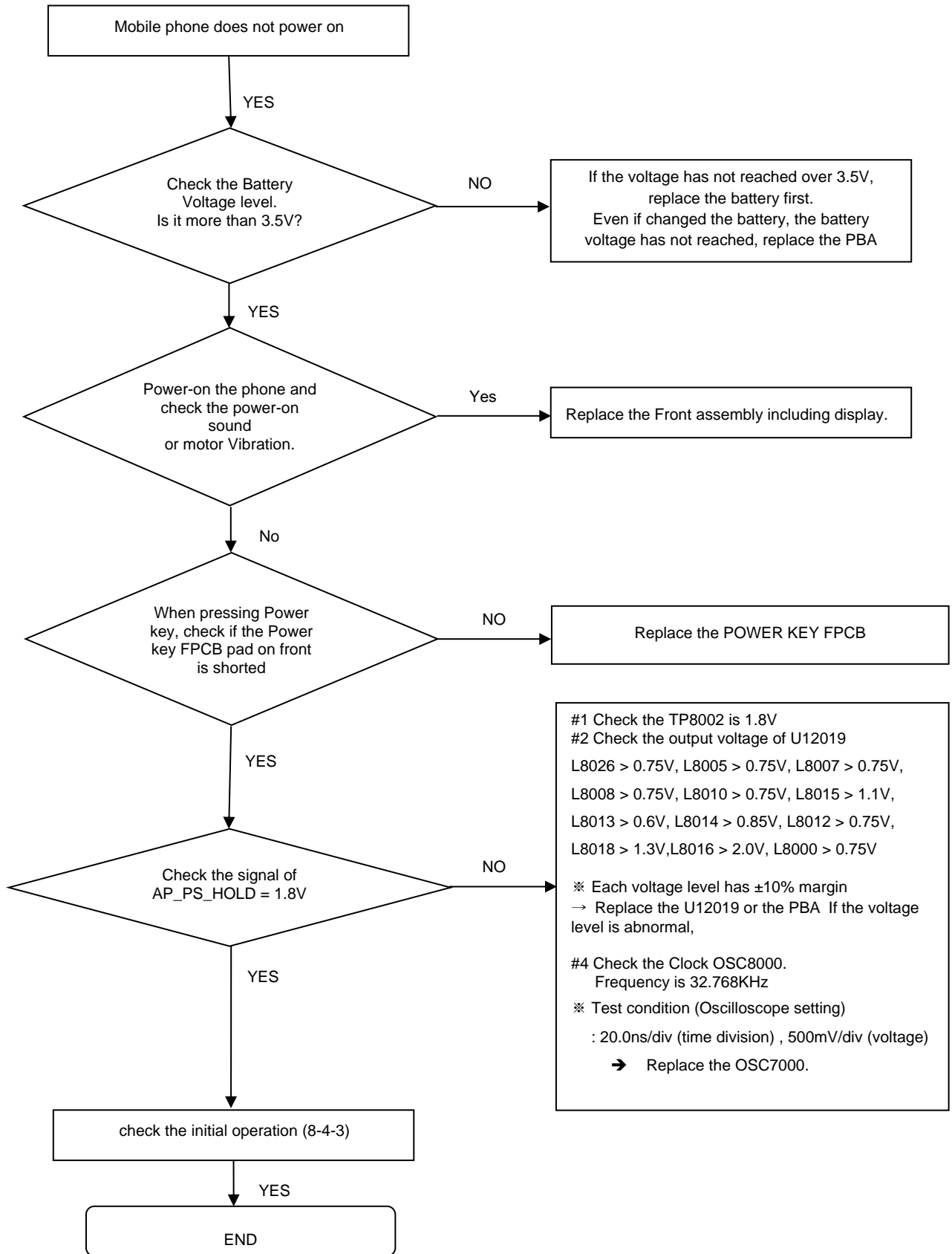

8. Level 3 Repair

8-4-2. Motor

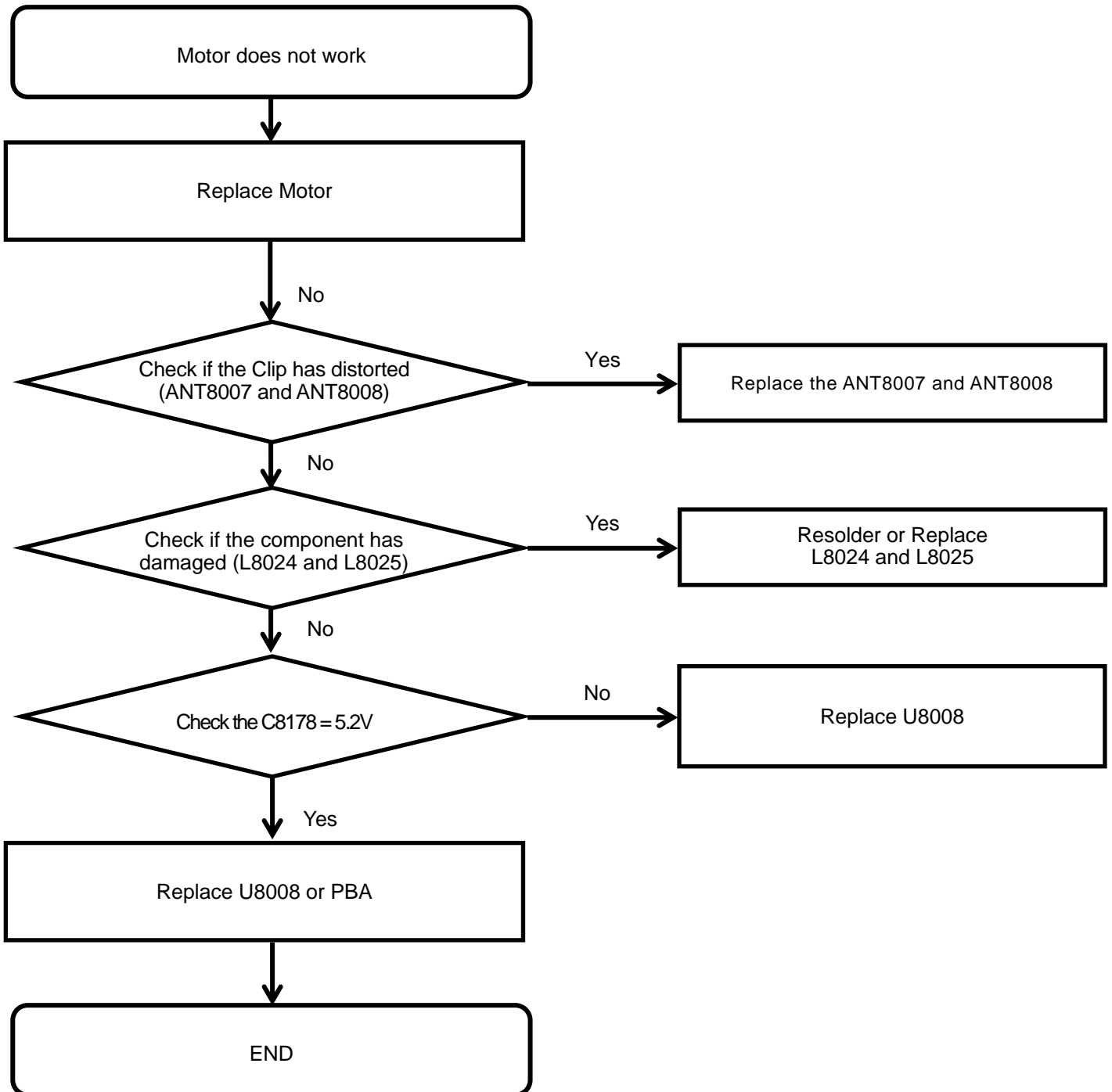

8. Level 3 Repair

8-4-3. initial

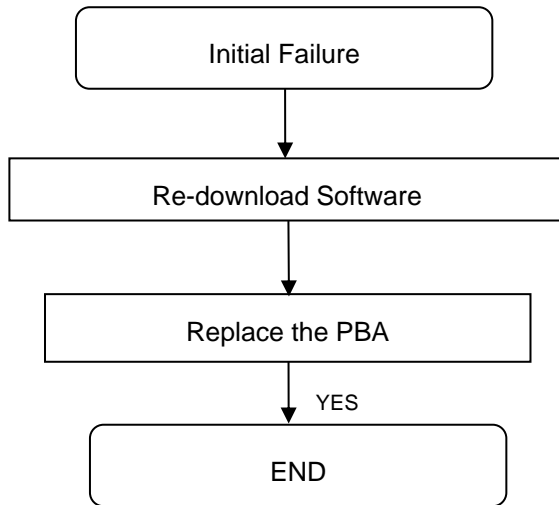

8. Level 3 Repair

8-4-4. SIM PART

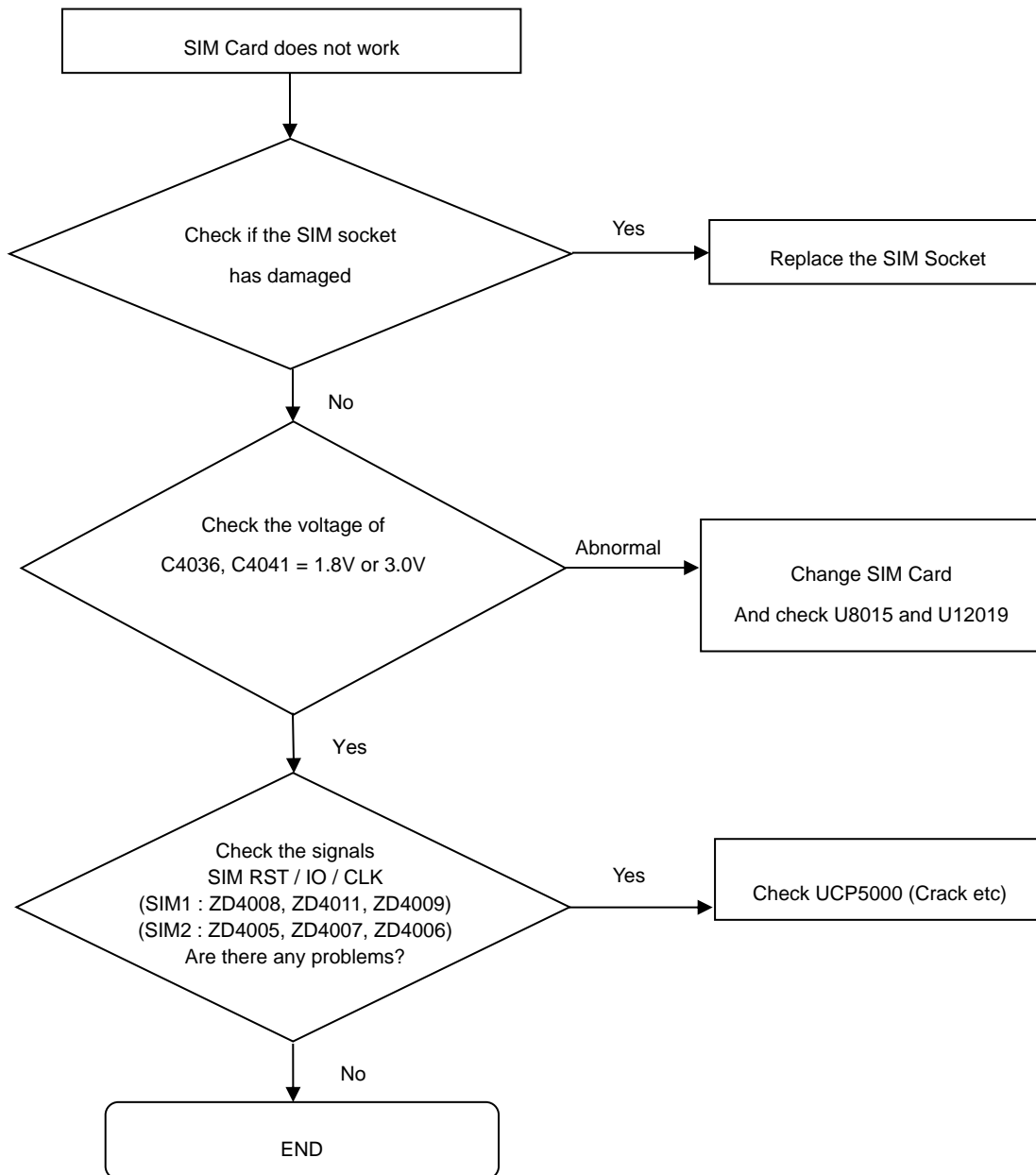

8. Level 3 Repair

8-4-5. SIM/SD PART

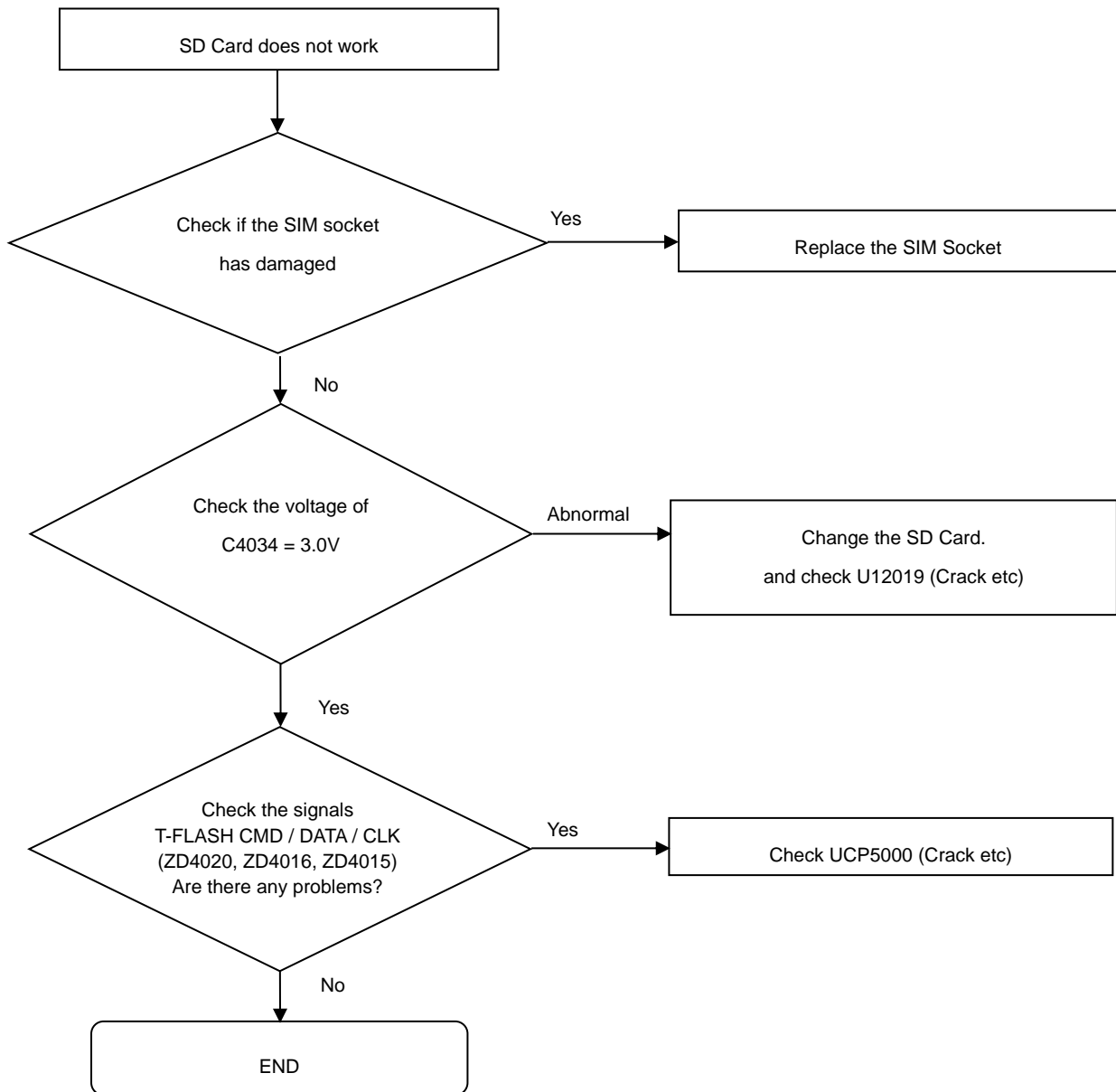

8. Level 3 Repair

8-4-6. OTG

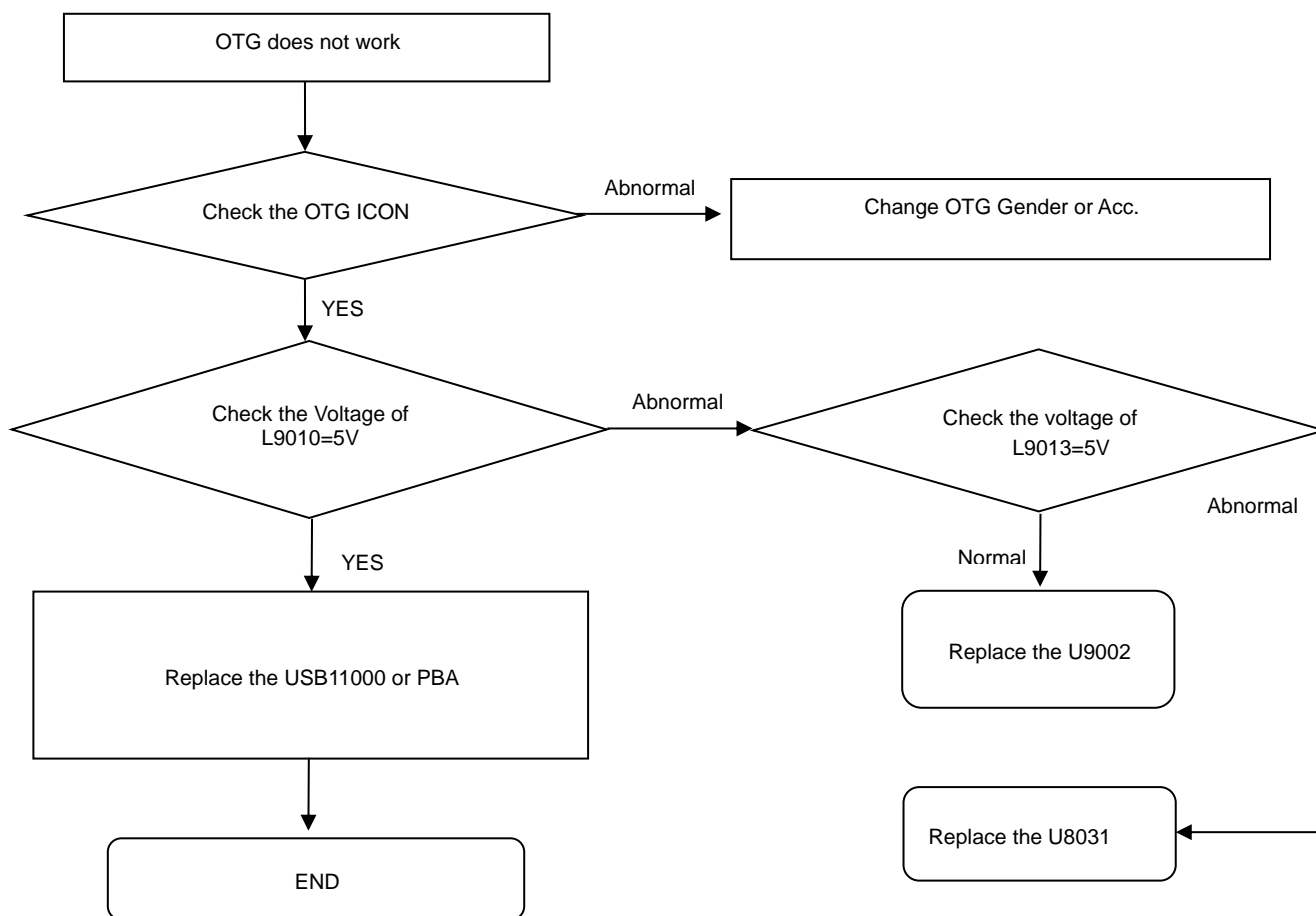

8. Level 3 Repair

8-4-7. Hall IC

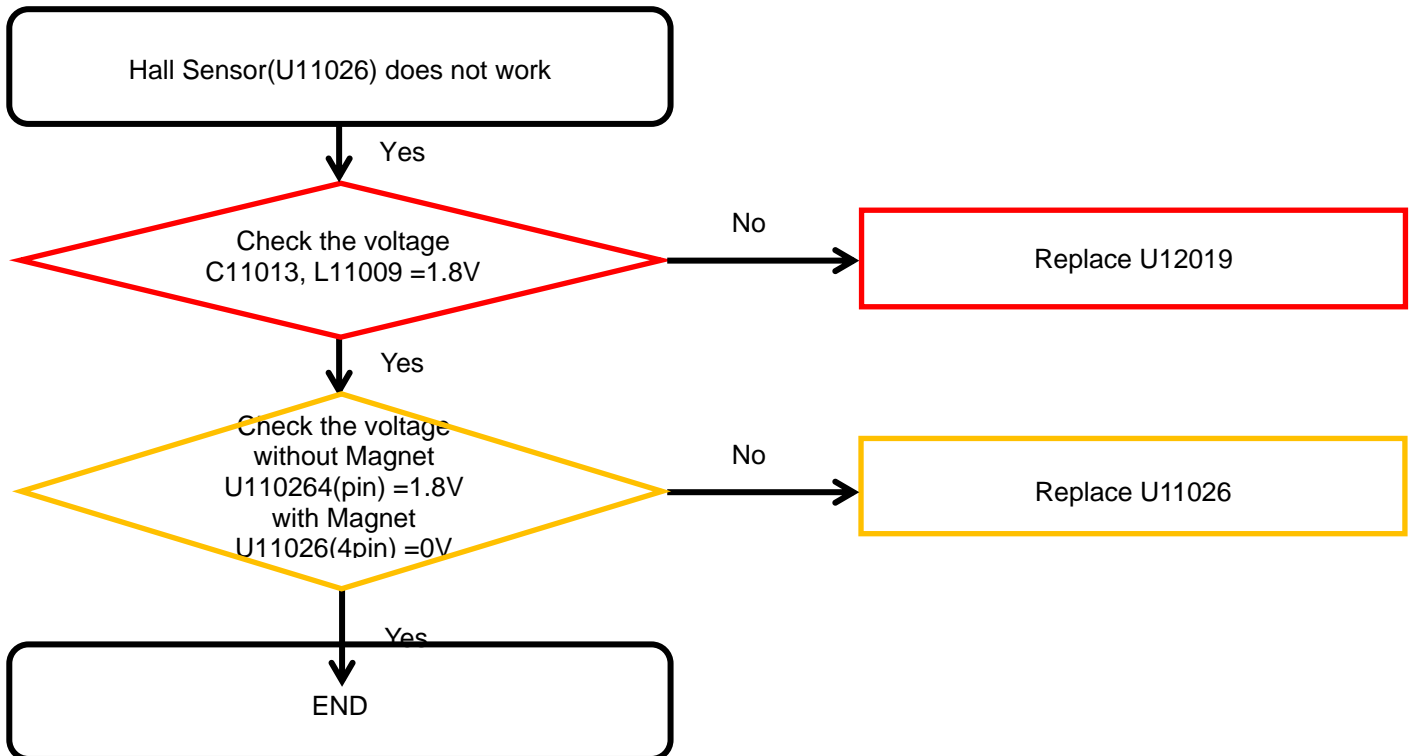
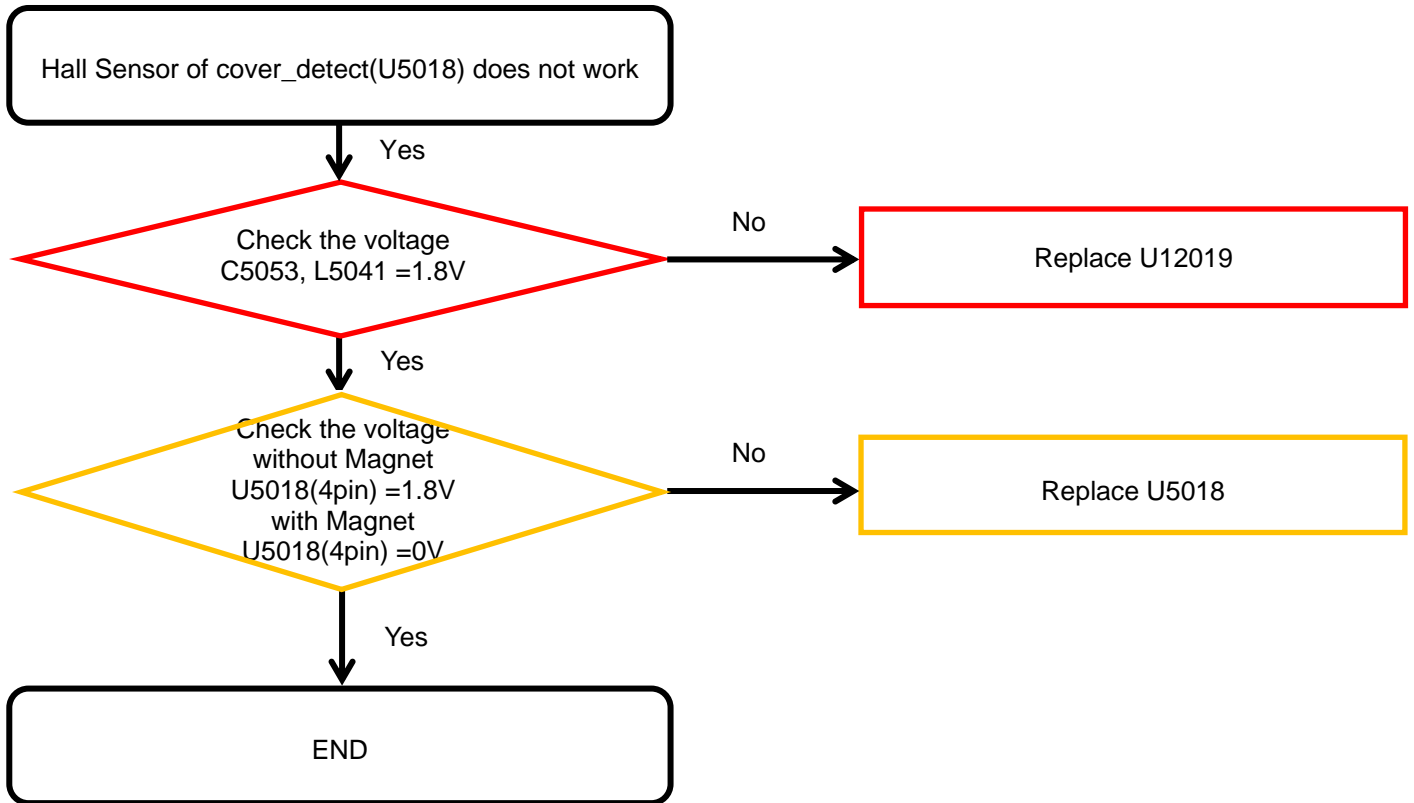

8. Level 3 Repair

8-4-8. 6Axis sensor

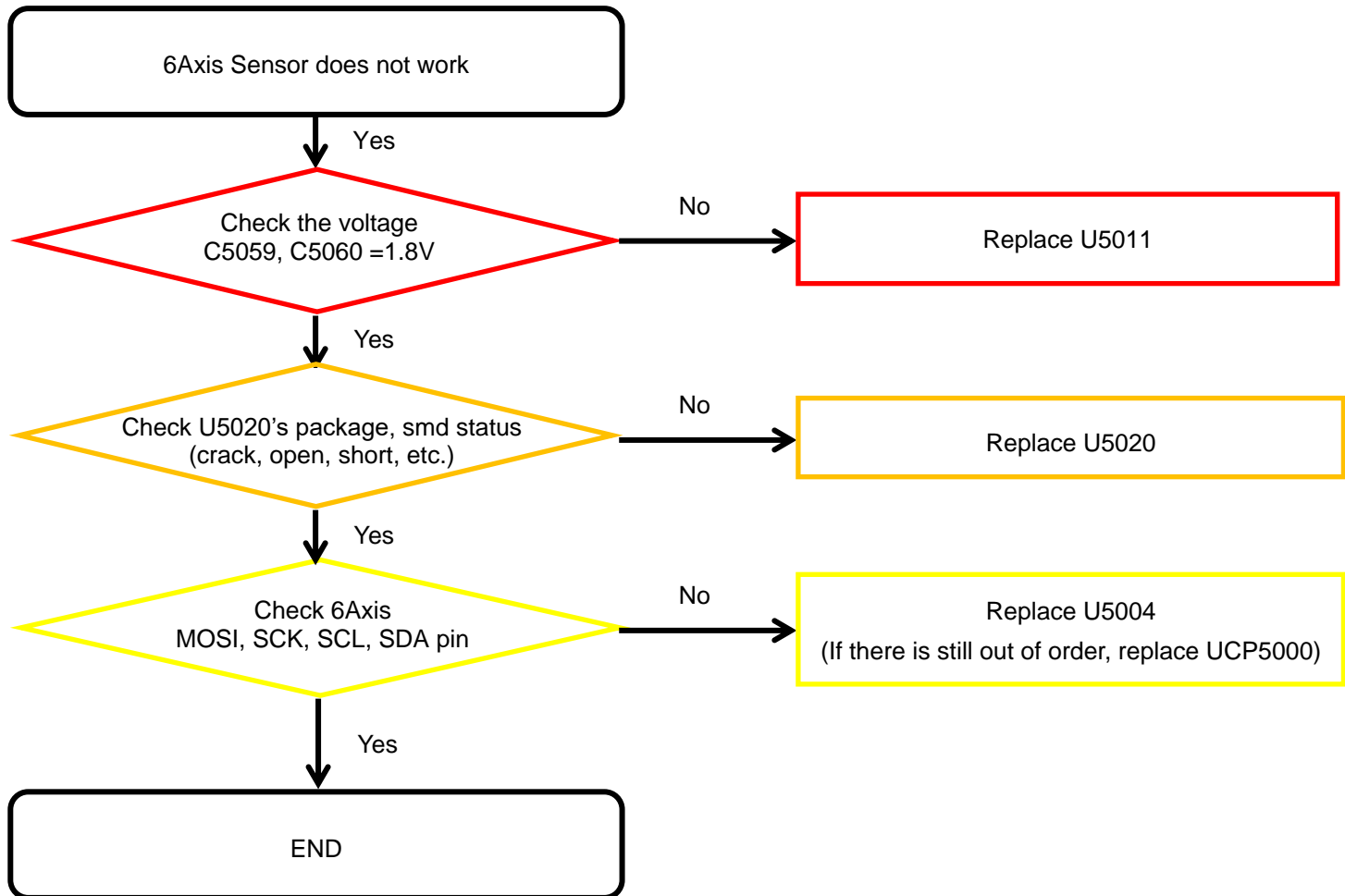

8. Level 3 Repair

8-4-9. Magnetic sensor

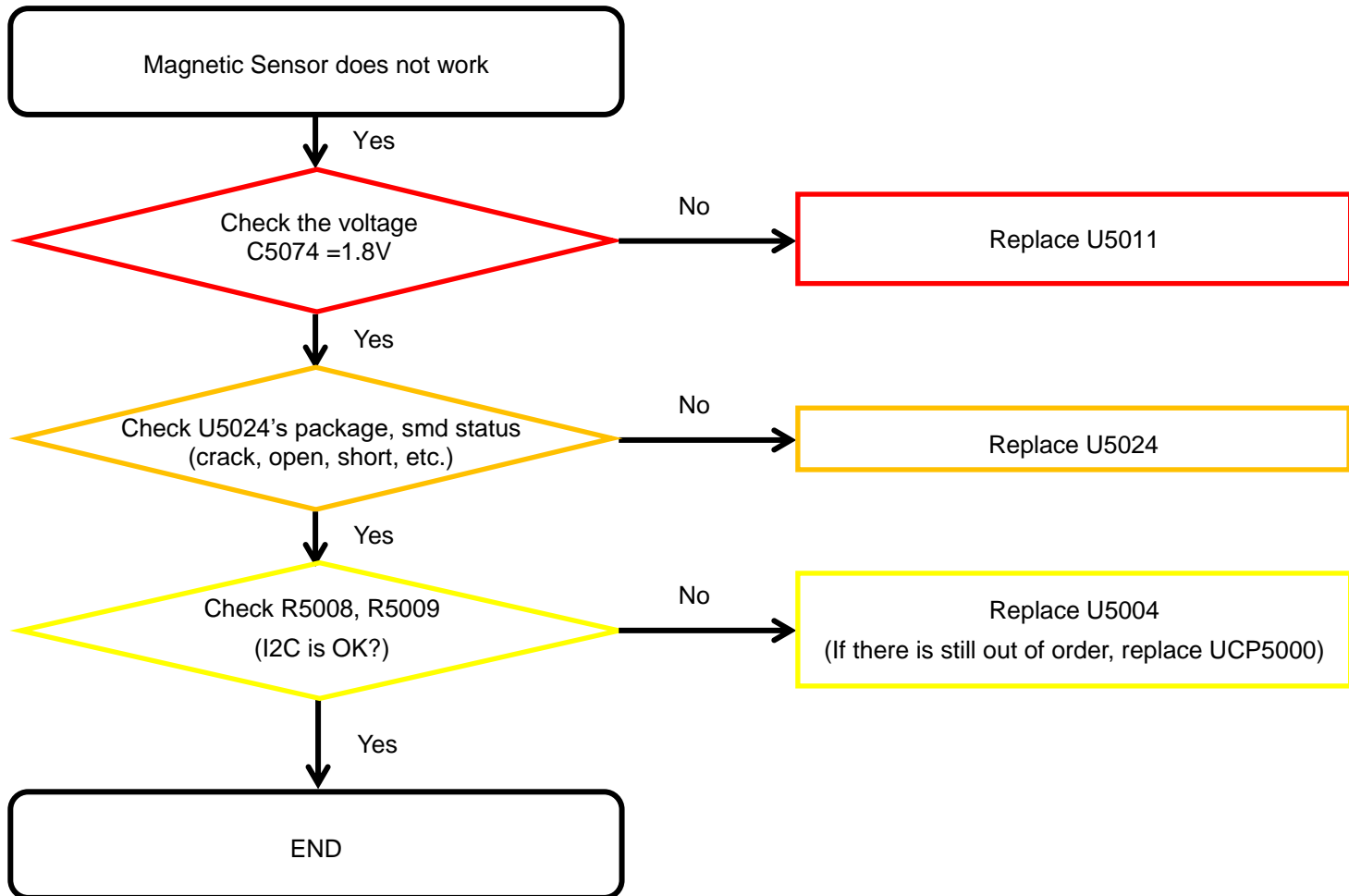

8. Level 3 Repair

8-4-10. Barometer sensor

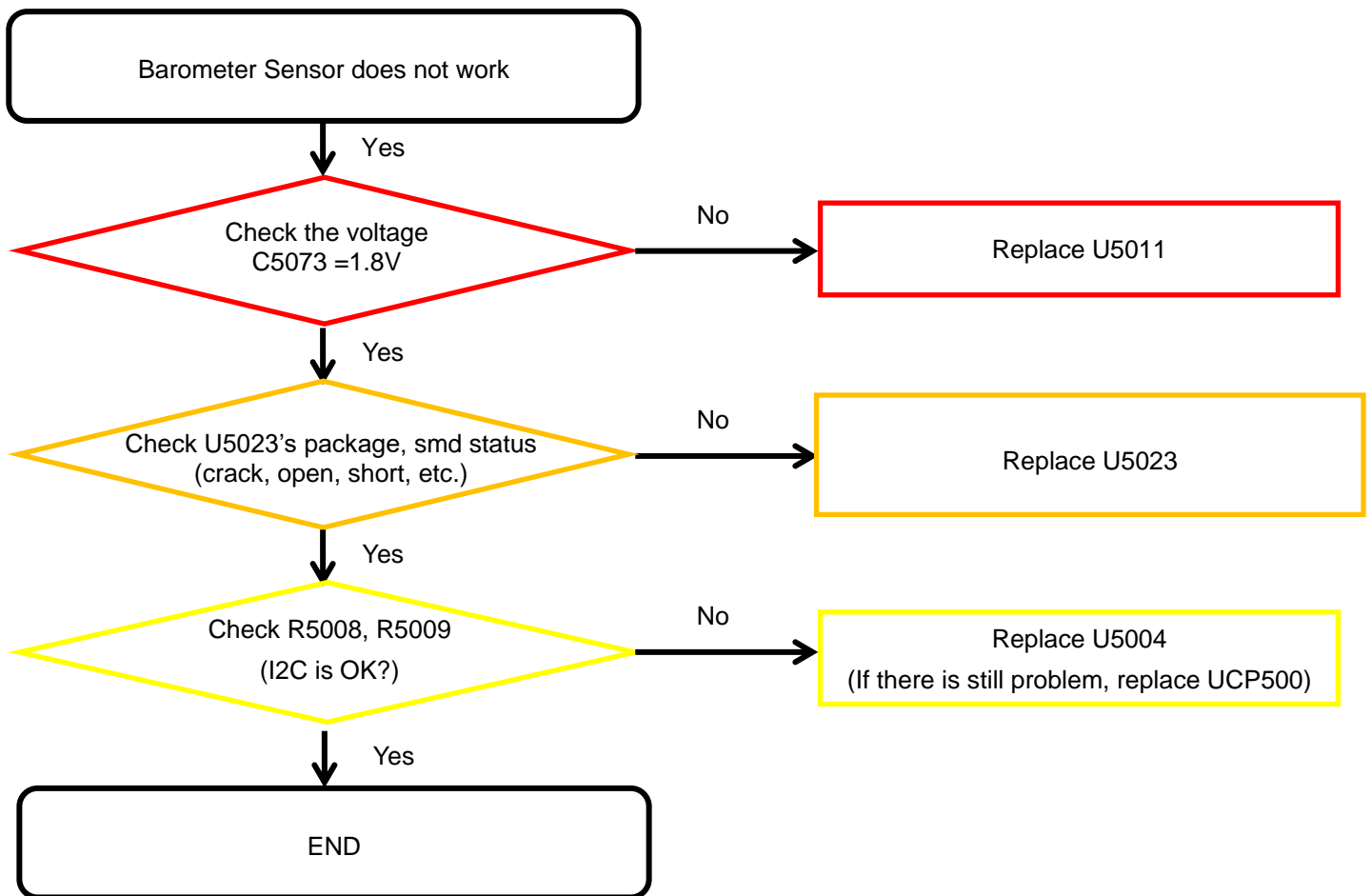

8. Level 3 Repair

8-4-11. Proximity/Ambient Light sensor

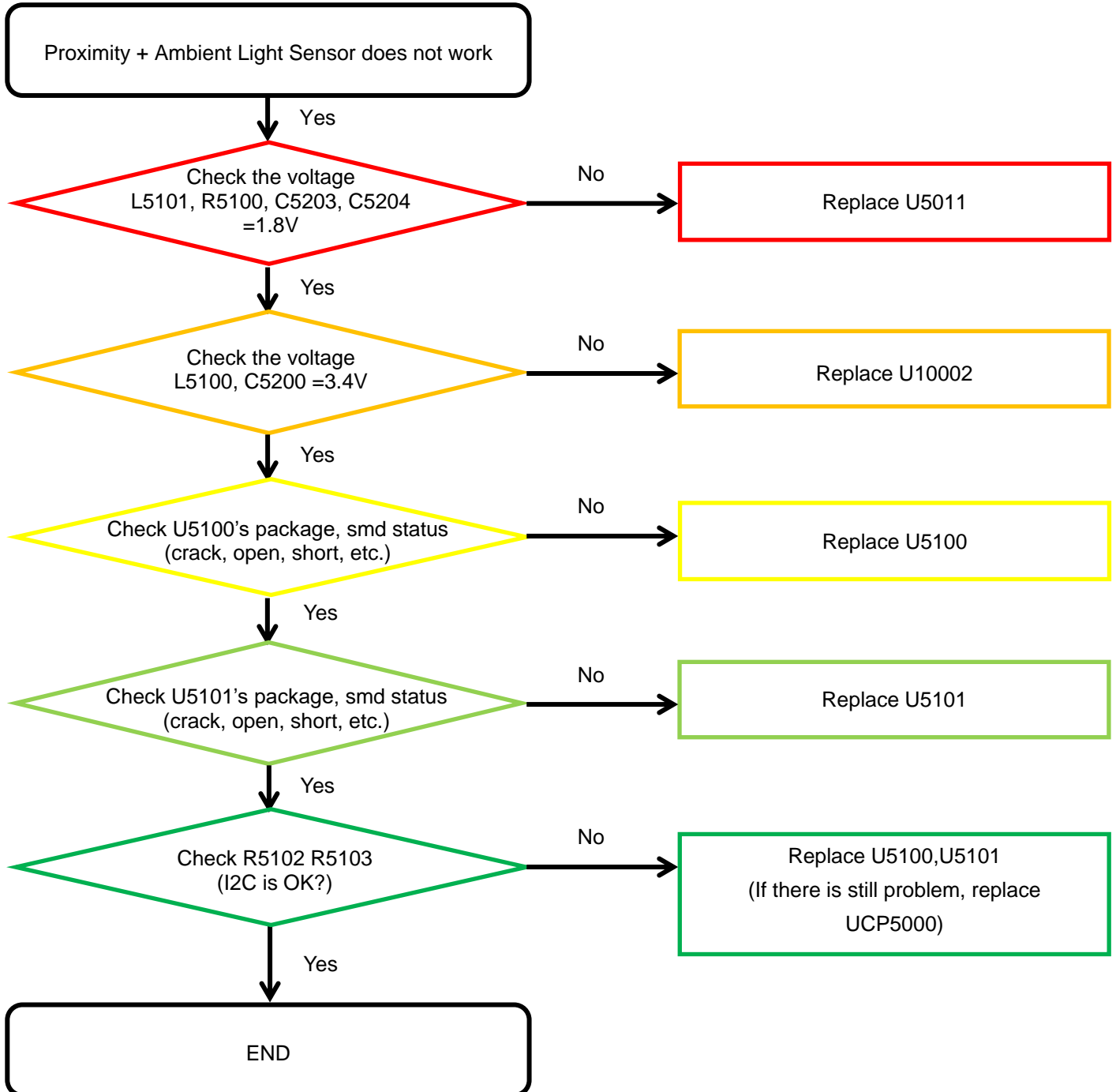

8. Level 3 Repair

8-4-12. HRM sensor

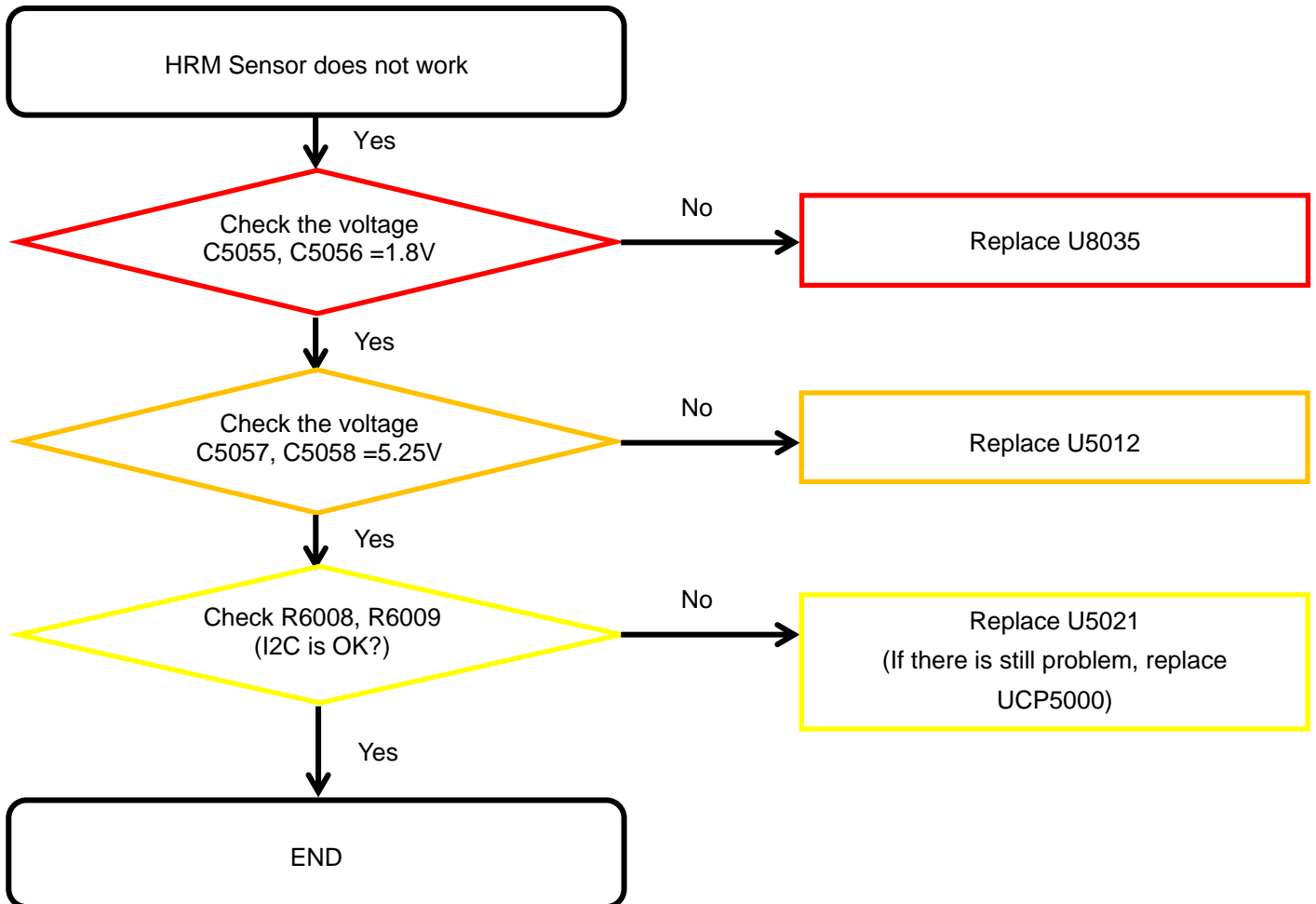

8. Level 3 Repair

8-4-13. Display

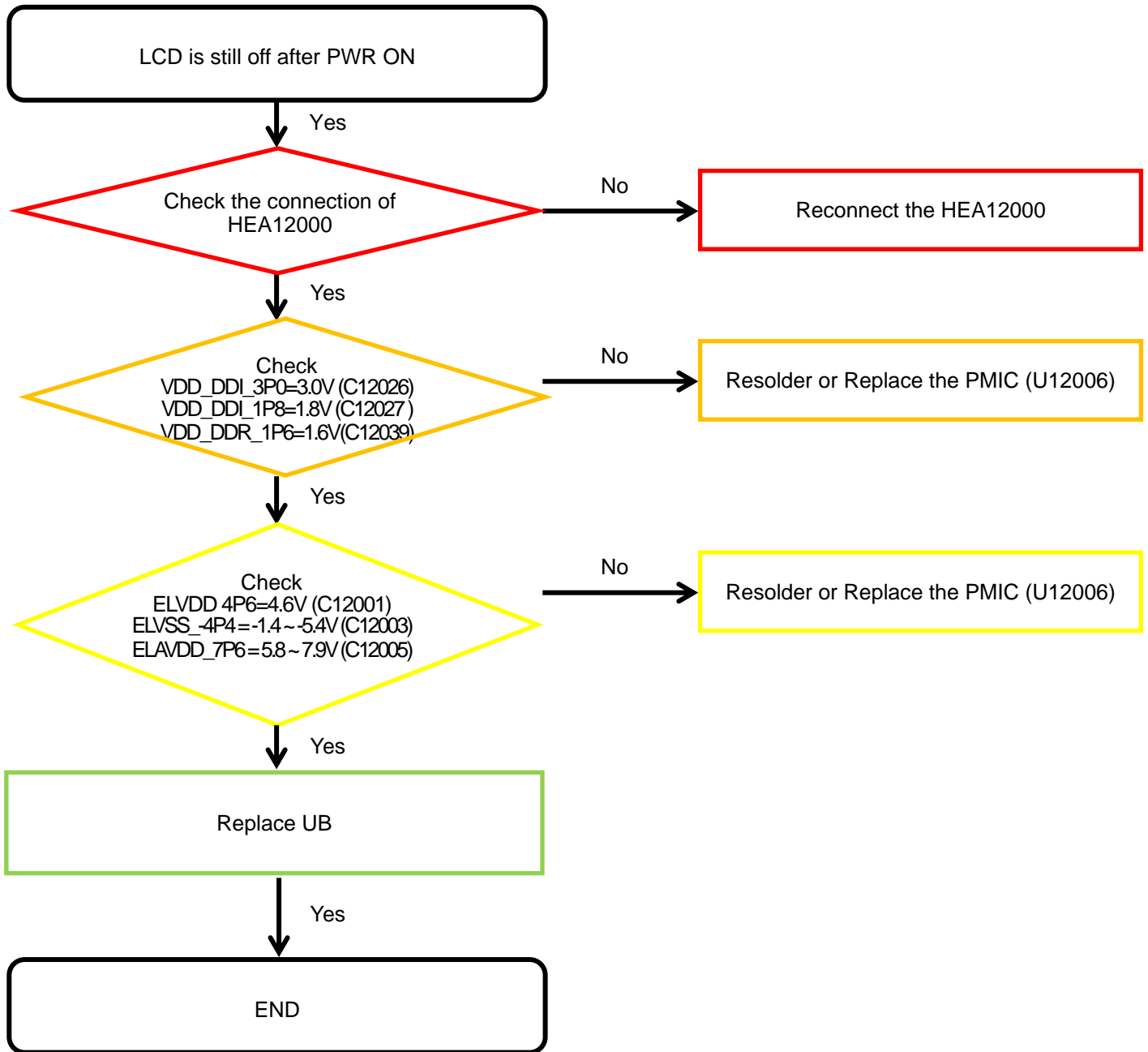

8. Level 3 Repair

8-4-14. TSP

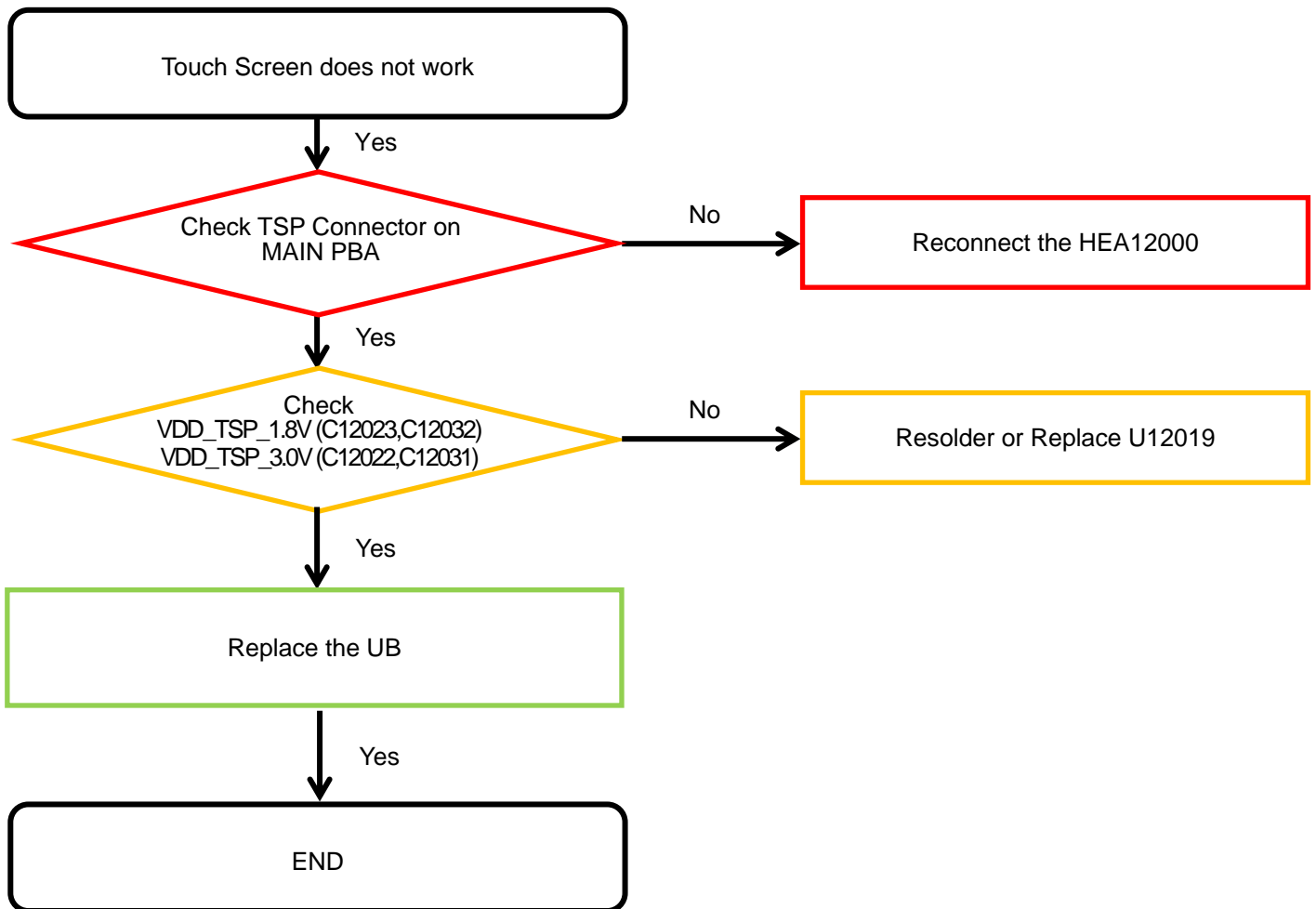

8. Level 3 Repair

8-4-15. VT CAMERA

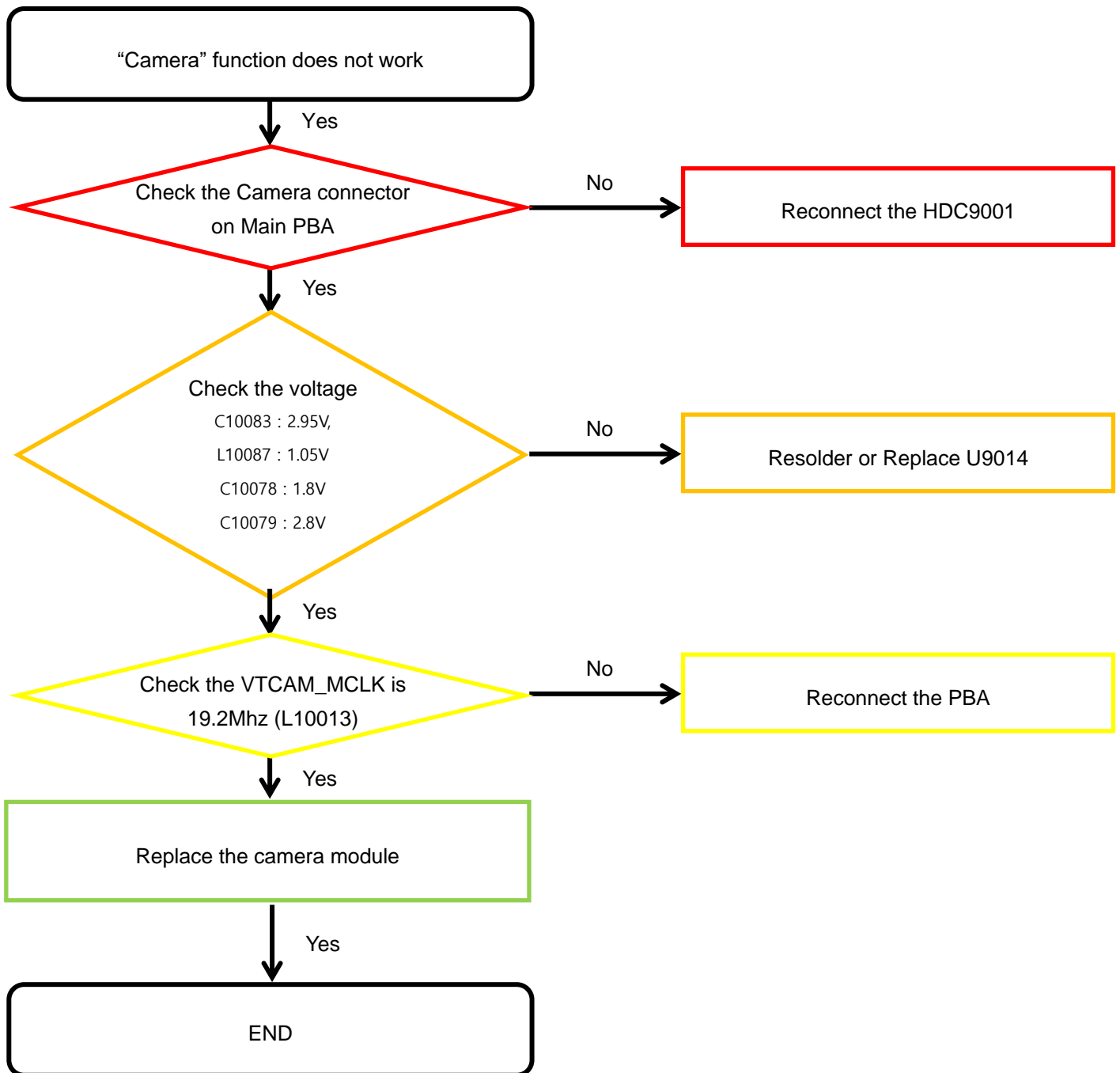

8. Level 3 Repair

8-4-16. Rear CAMERA

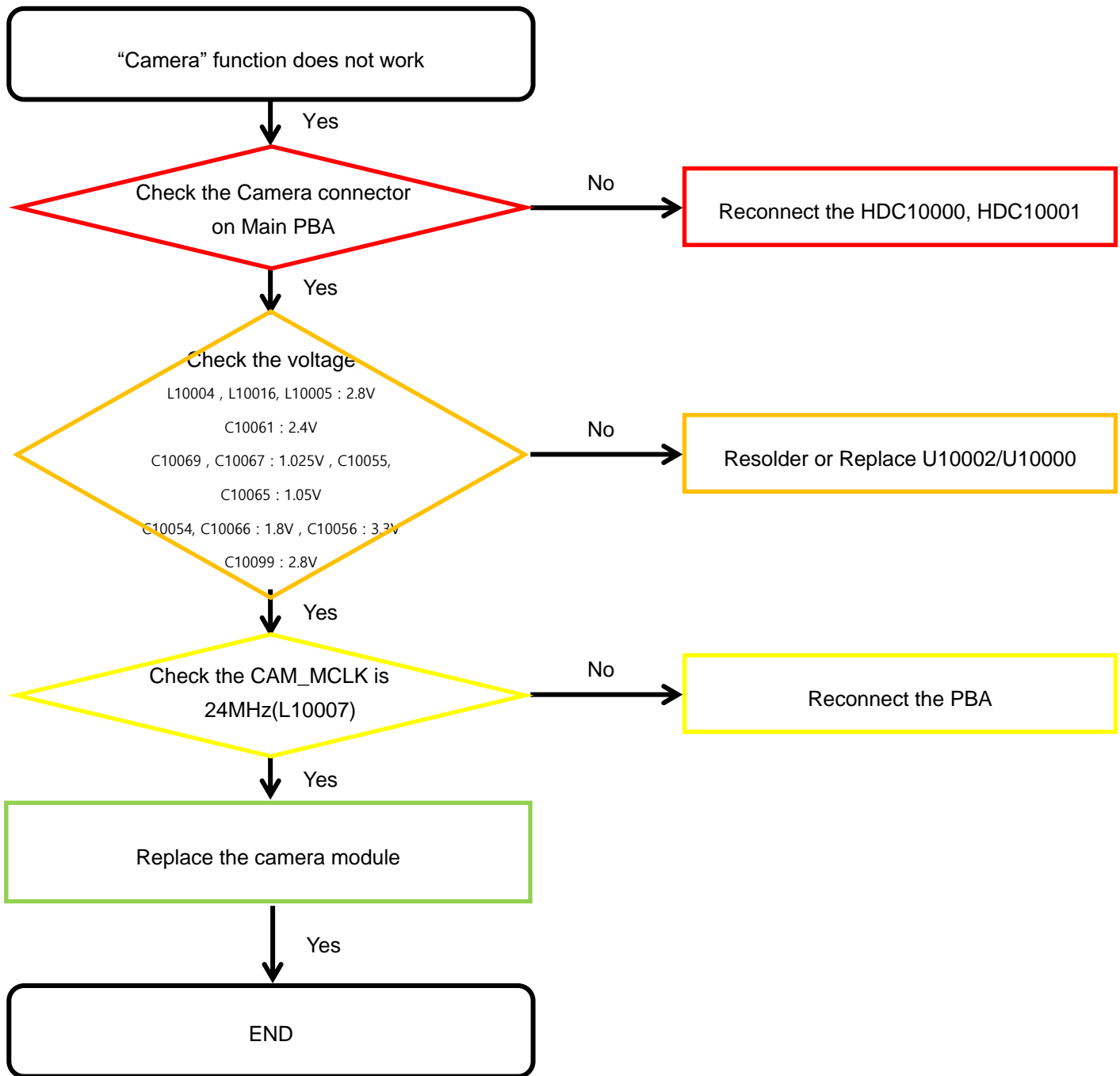

8. Level 3 Repair

8-4-17. Finger Print

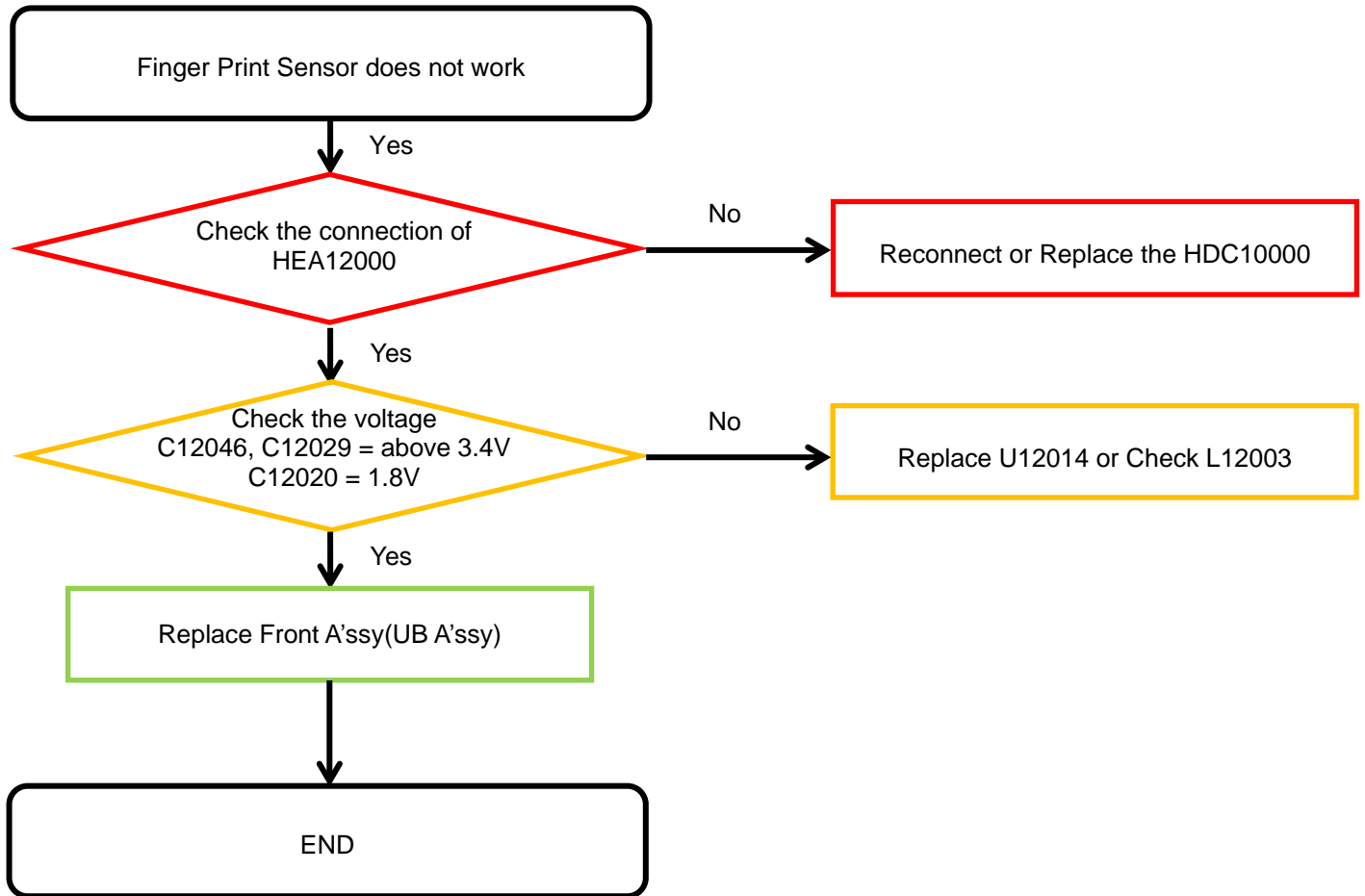

8. Level 3 Repair

8-4-18-1. Main MIC

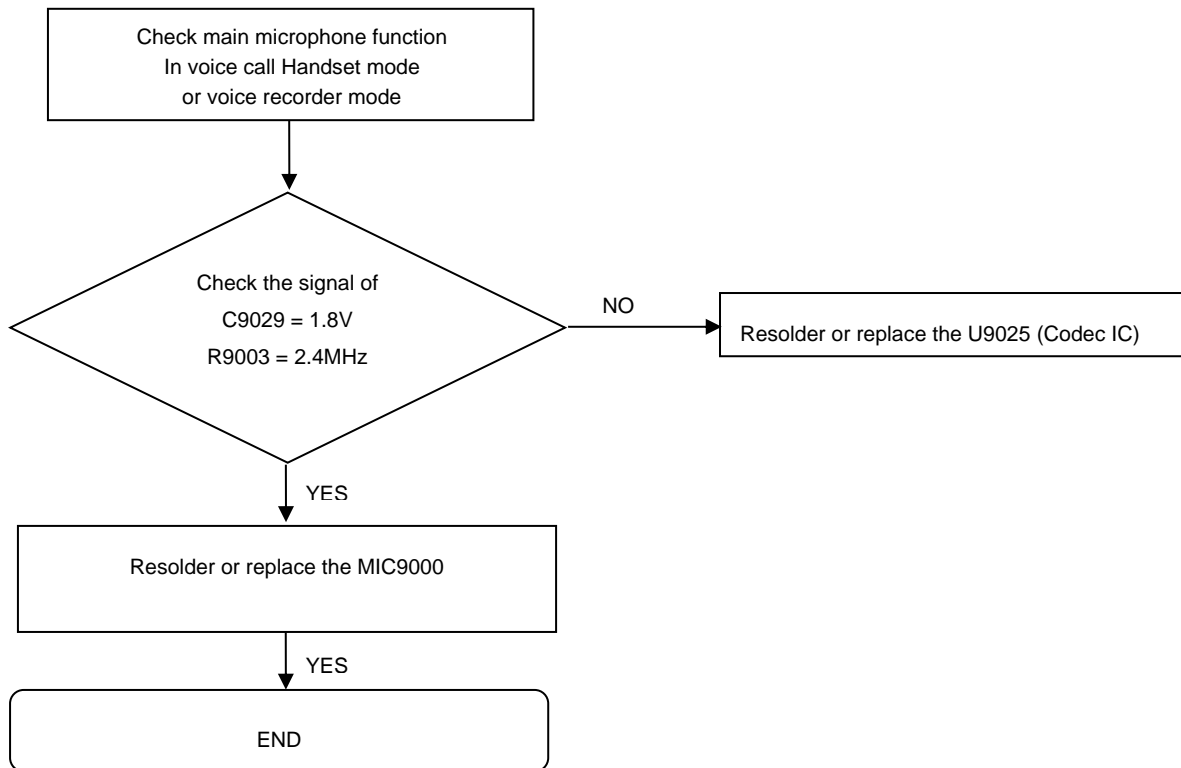

8. Level 3 Repair

8-4-18-2. Sub(2nd) MIC

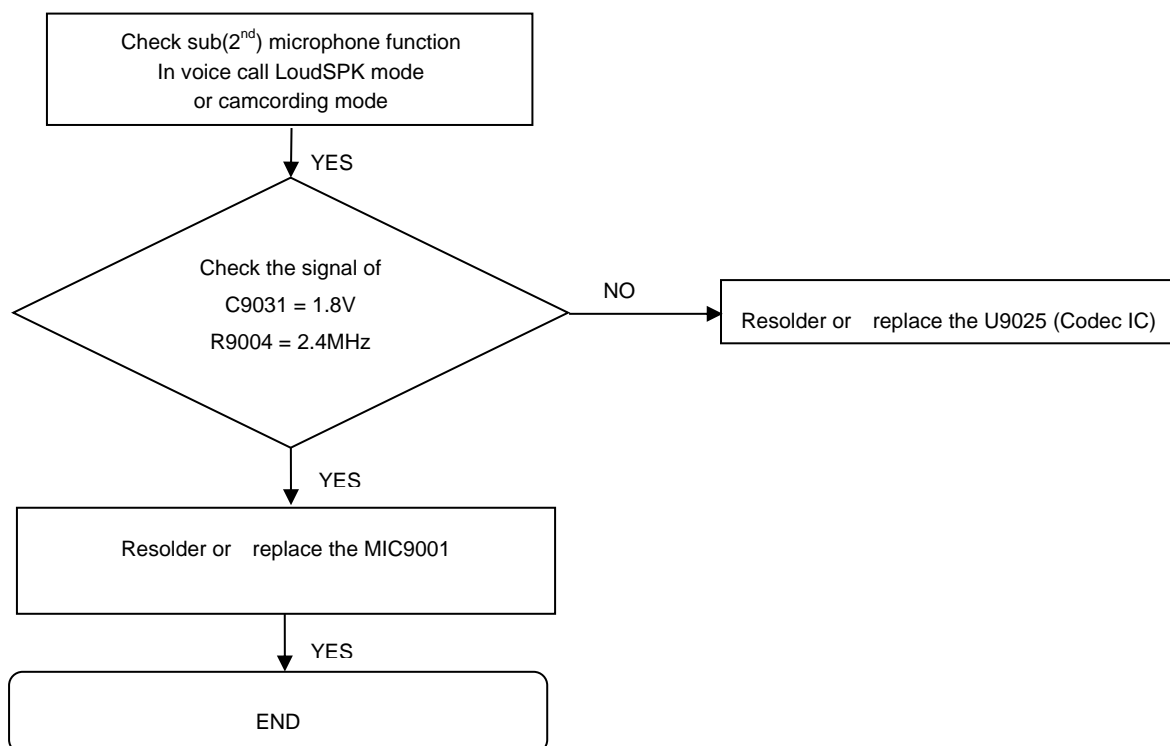

8. Level 3 Repair

8-4-19. Speaker part

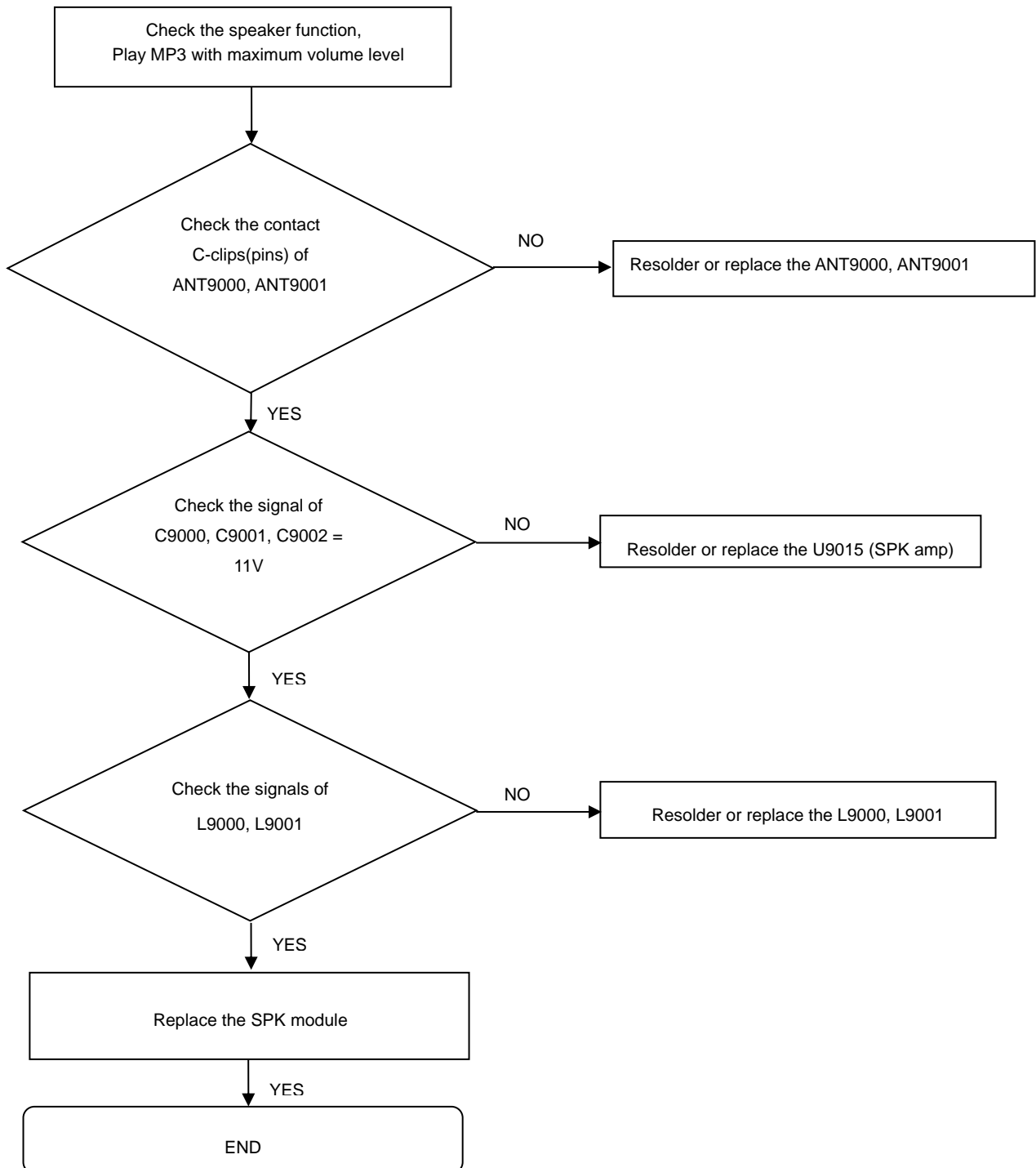

8. Level 3 Repair

8-4-20. Receiver part

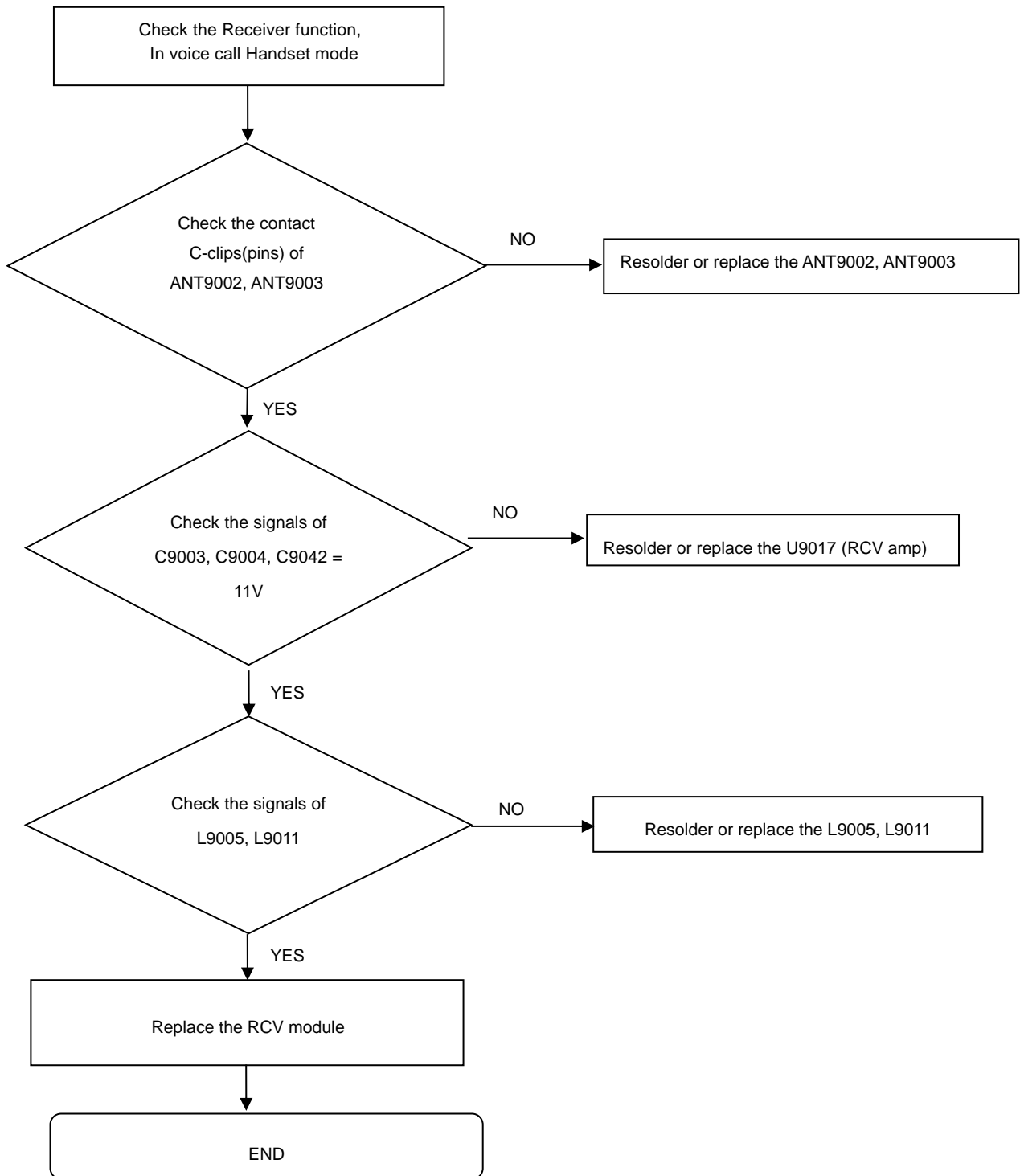

8. Level 3 Repair

8-4-21. BT/WIFI

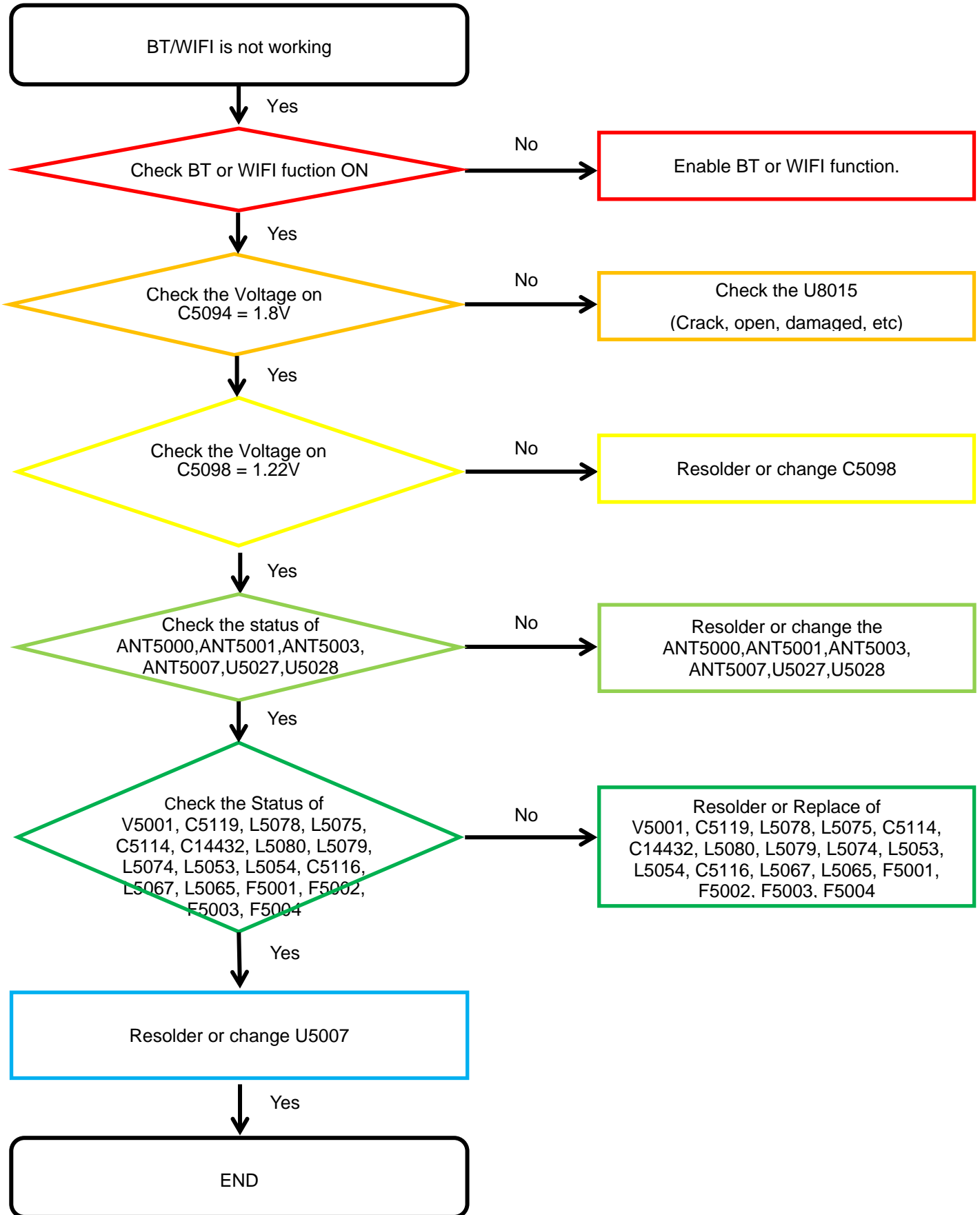

8. Level 3 Repair

8-4-22. GPS

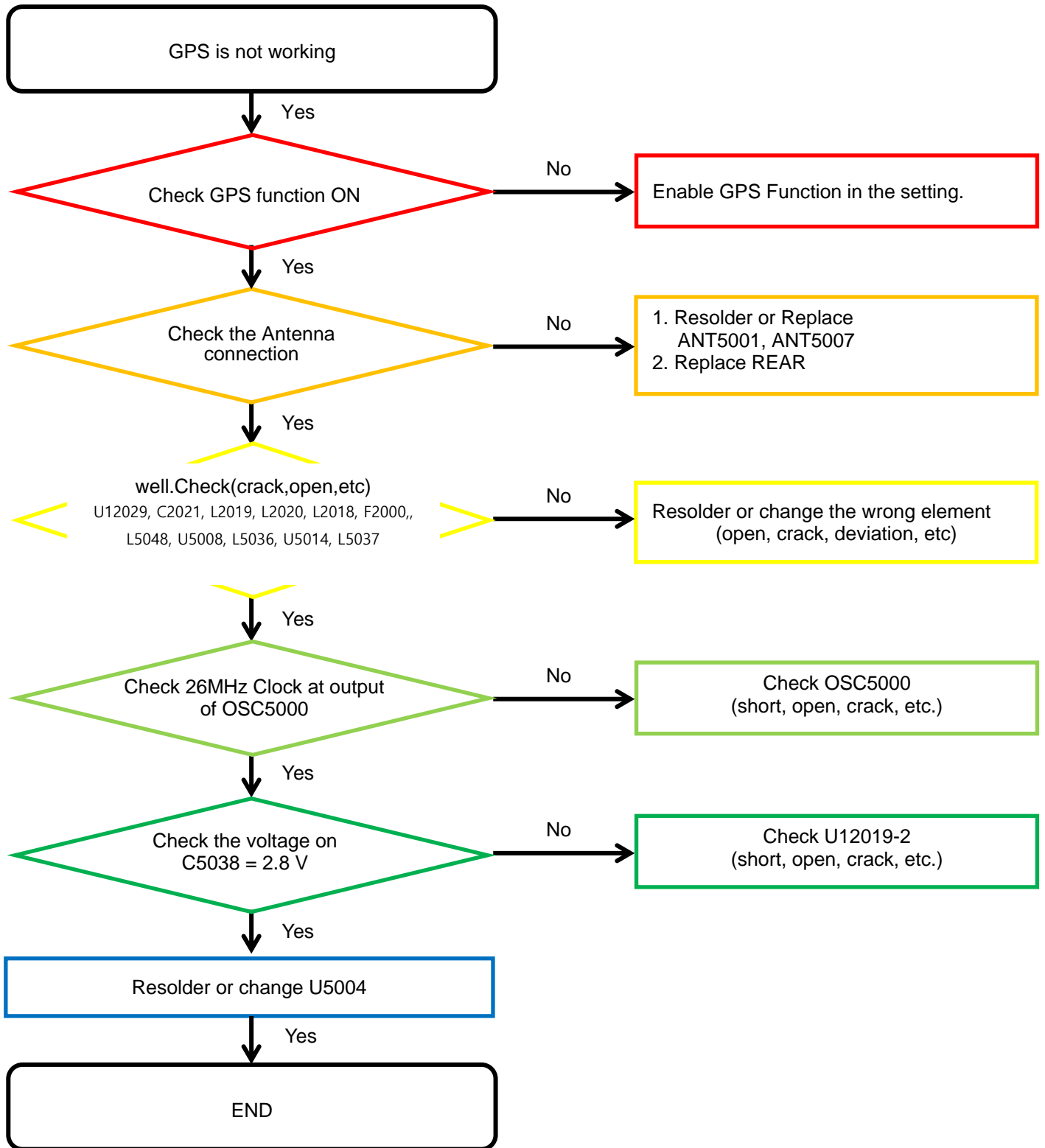

8. Level 3 Repair

8-4-23. NFC

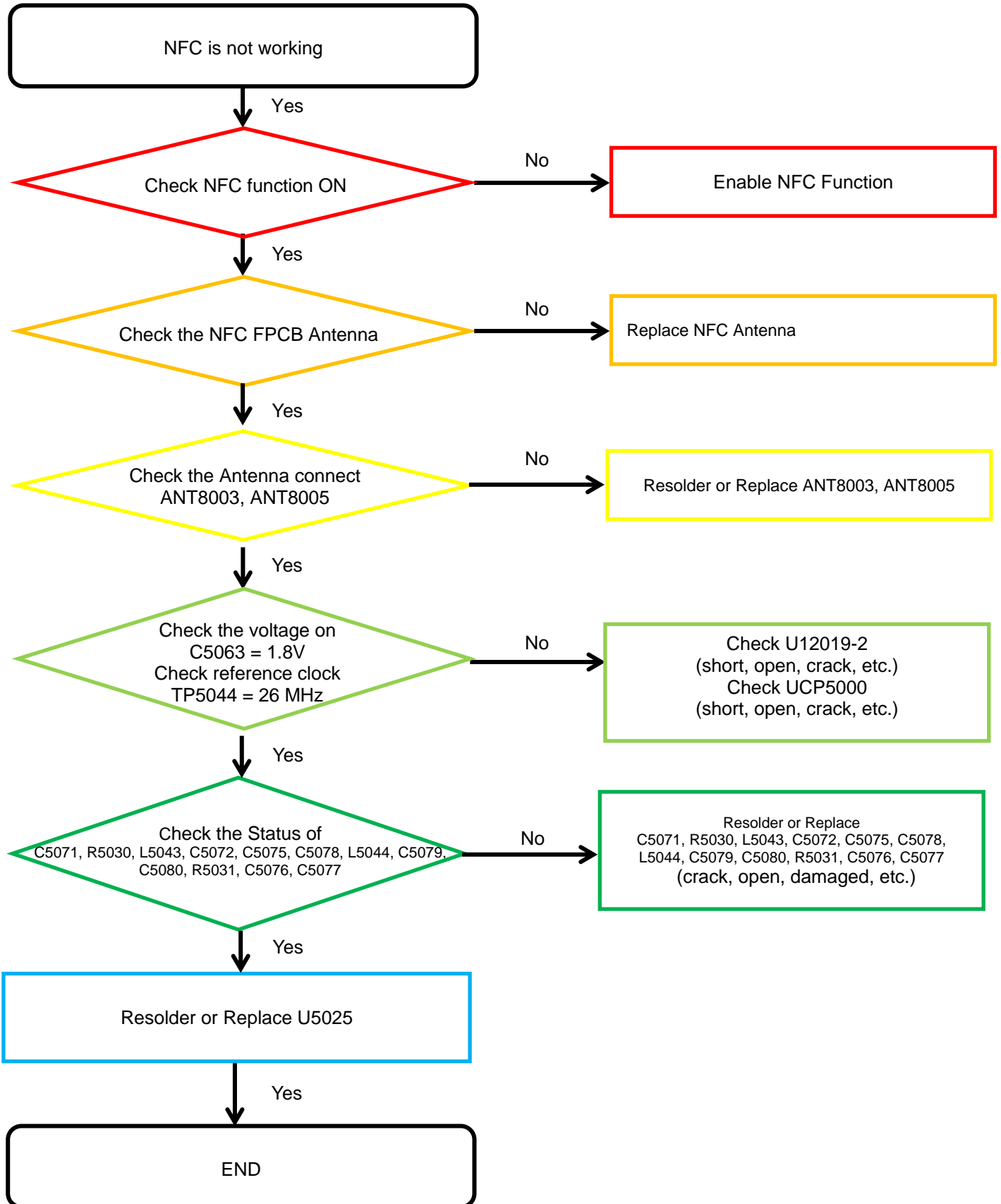

8. Level 3 Repair

8-4-24. MST

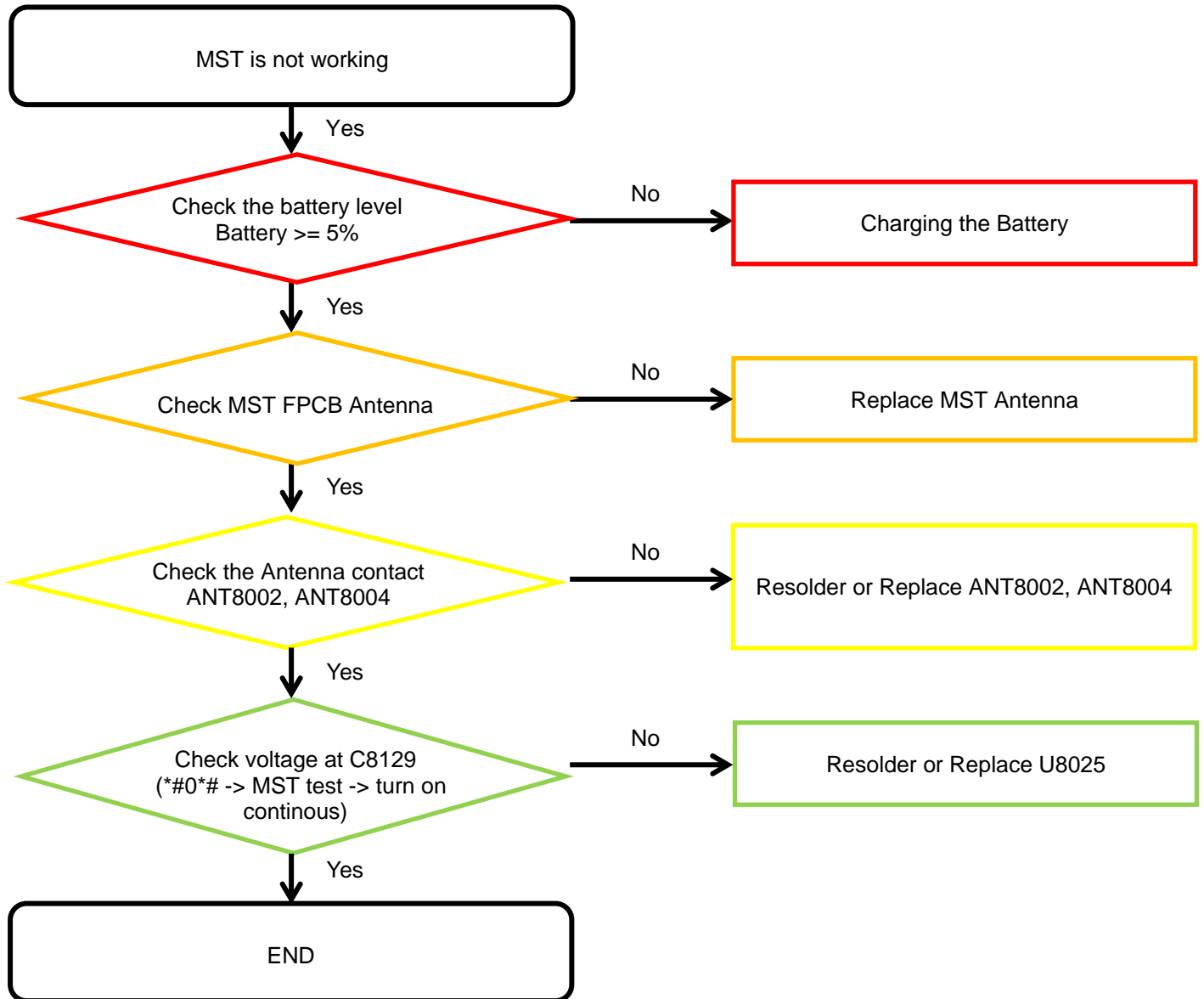

8. Level 3 Repair

8-4-25. Charging Part Wire Charging (Normal/Fast)

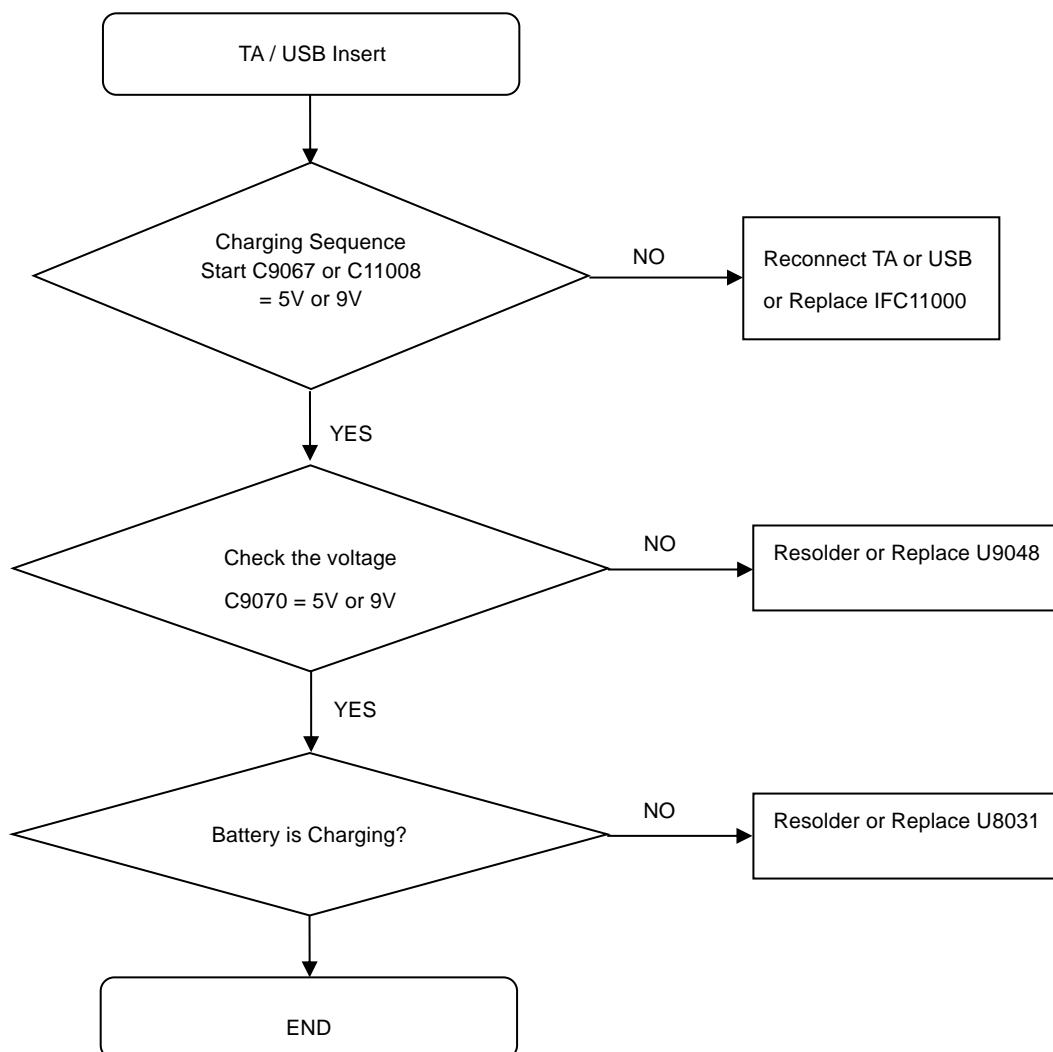

8. Level 3 Repair

8-4-26. Charging Part Wireless Charging (Normal/Fast)

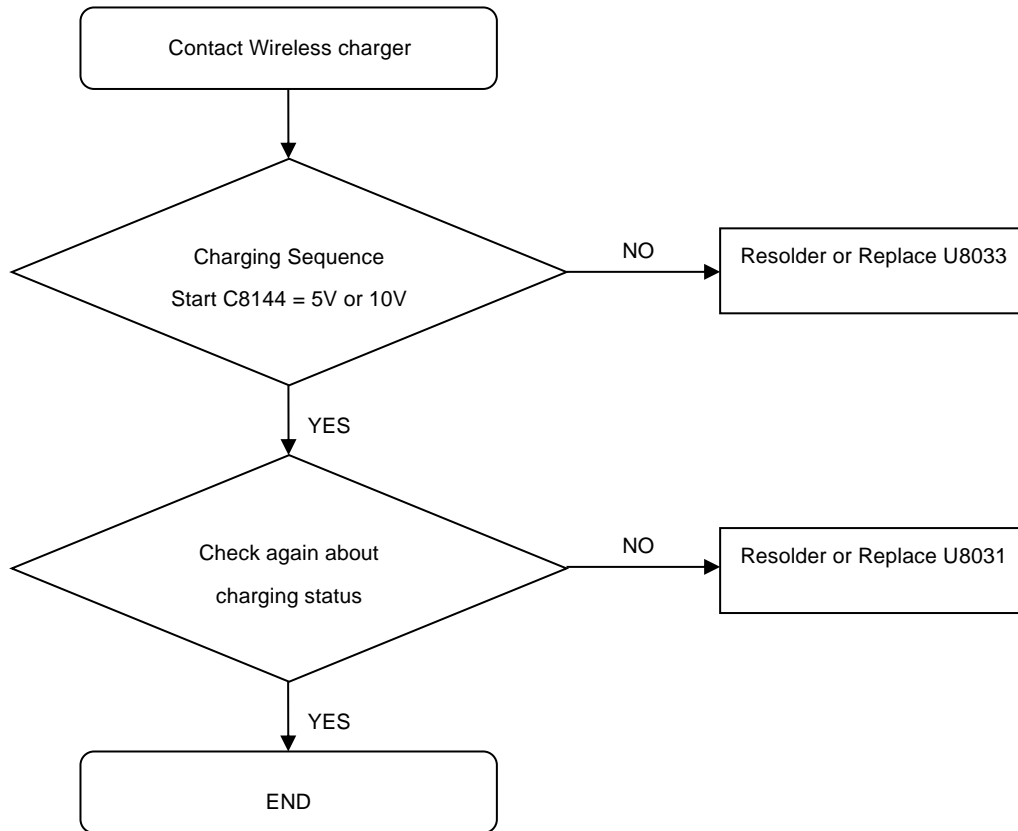

8. Level 3 Repair

8-4-27. GSM 850/900, WCDMA B5/8, LTE B5/8/12/13/14/17/18/19/ 20/26/28 RX

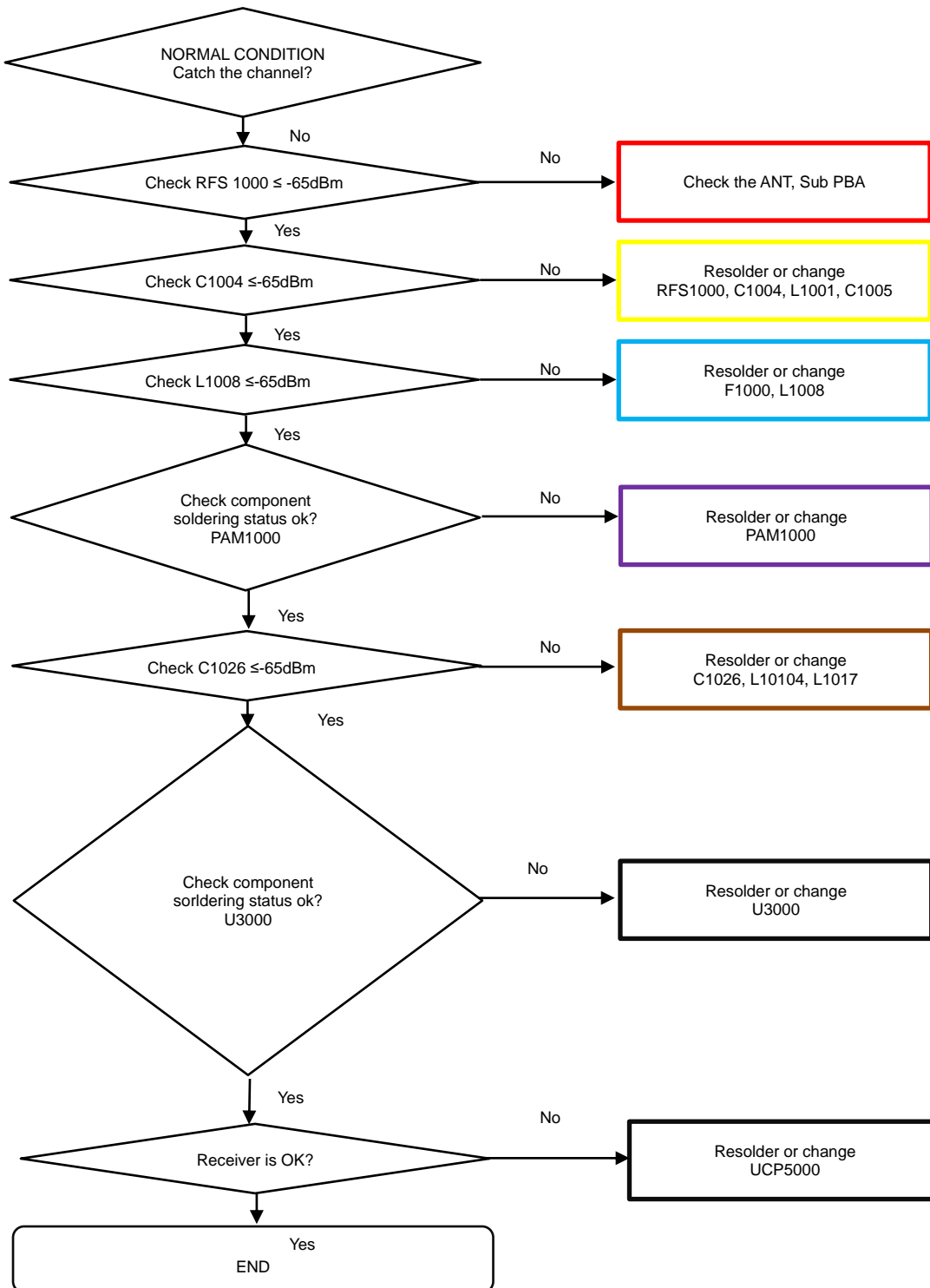

8. Level 3 Repair

8-4-28. GSM 1800/1900, WCDMA B1/2/4, TDSCDMA B34/39, LTE B1/2/3/4/25/39/66 RX

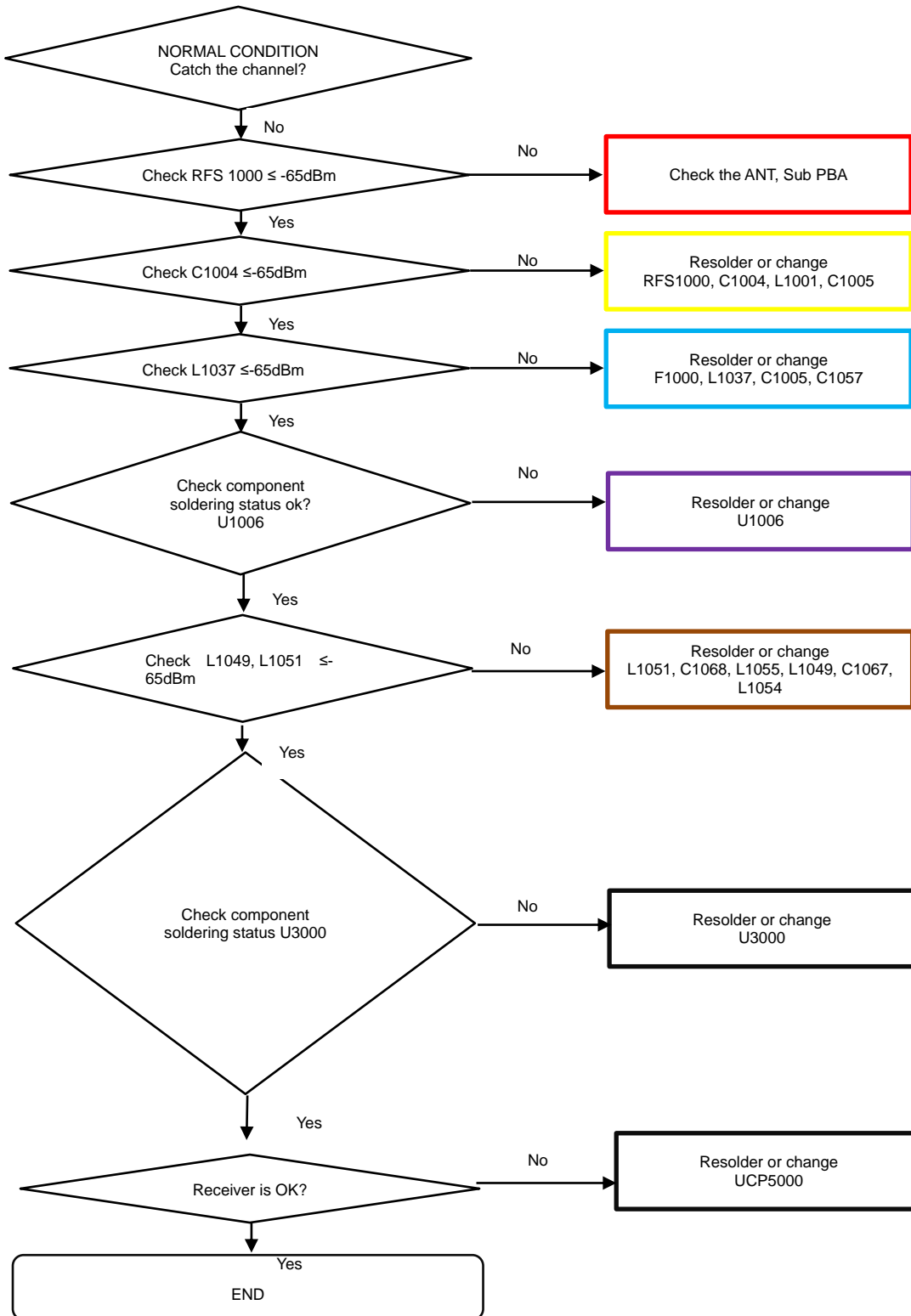

8. Level 3 Repair

8-4-29. LTE B7/38/41 RX

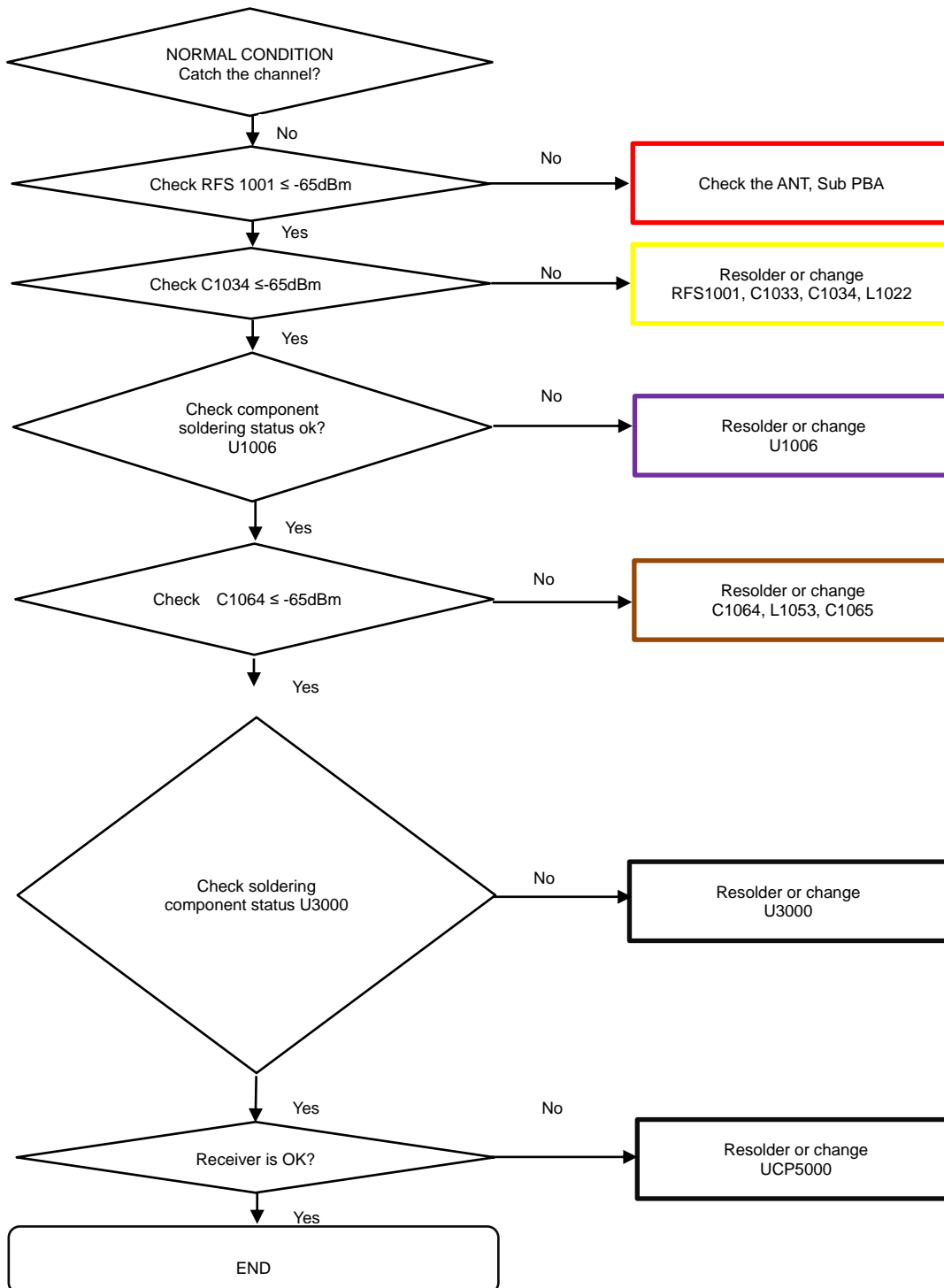

8. Level 3 Repair

8-4-30. GSM 850/900, WCDMA B5/8, LTE B5/8/12/13/17/18/19/20/26/28 DRX

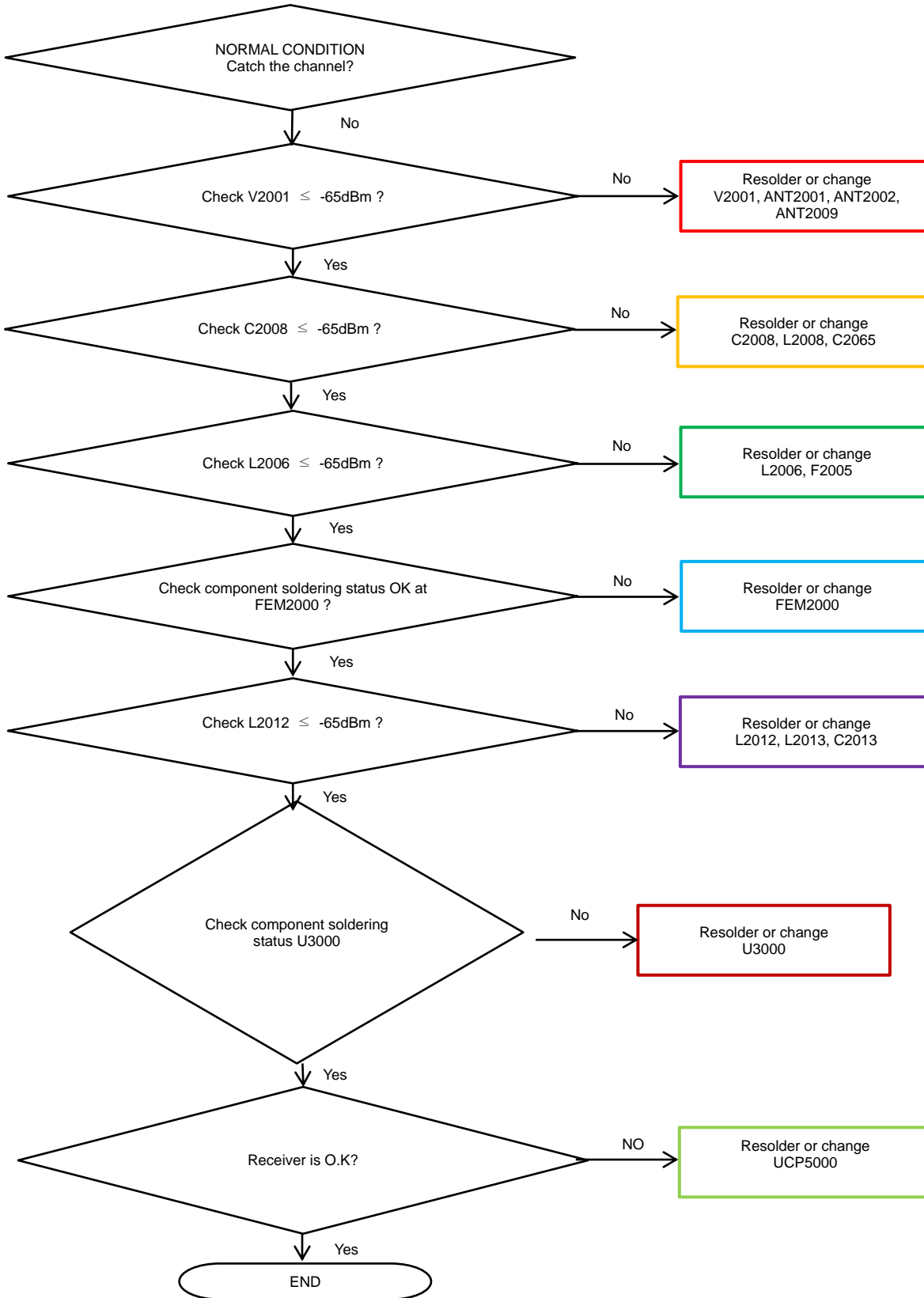

8. Level 3 Repair

8-4-31. GSM1800/1900, WCDMA 1/2/4, LTE B1/2/3/4/7/25/32/66 DRX

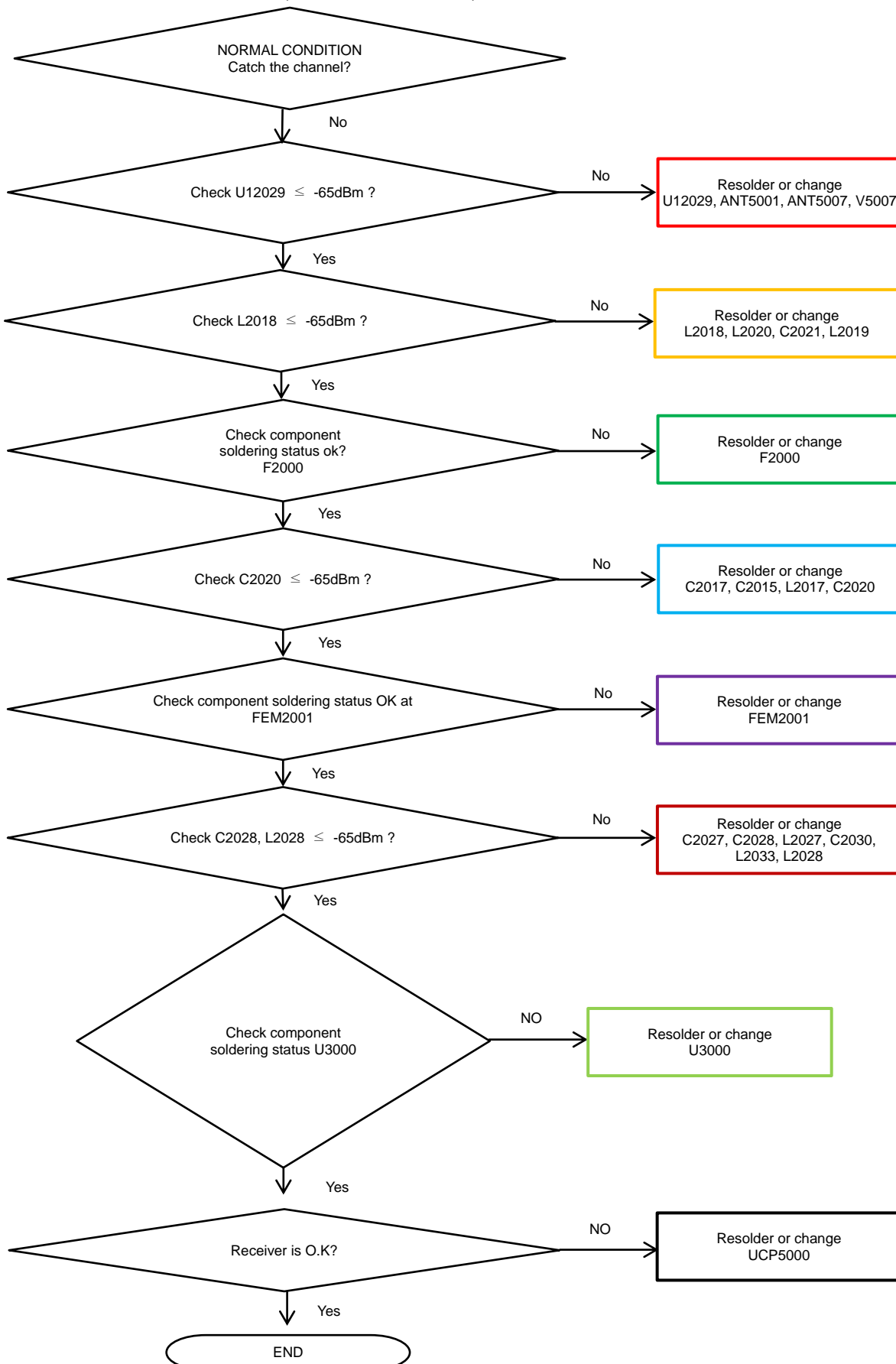

Confidential and proprietary-the contents in this service guide subject to change without prior notice

Distribution, transmission, or infringement of any content or data from this document without Samsung's written authorization is strictly prohibited.

8. Level 3 Repair

8-3-32. LTE TDD 38/40/41 DRX

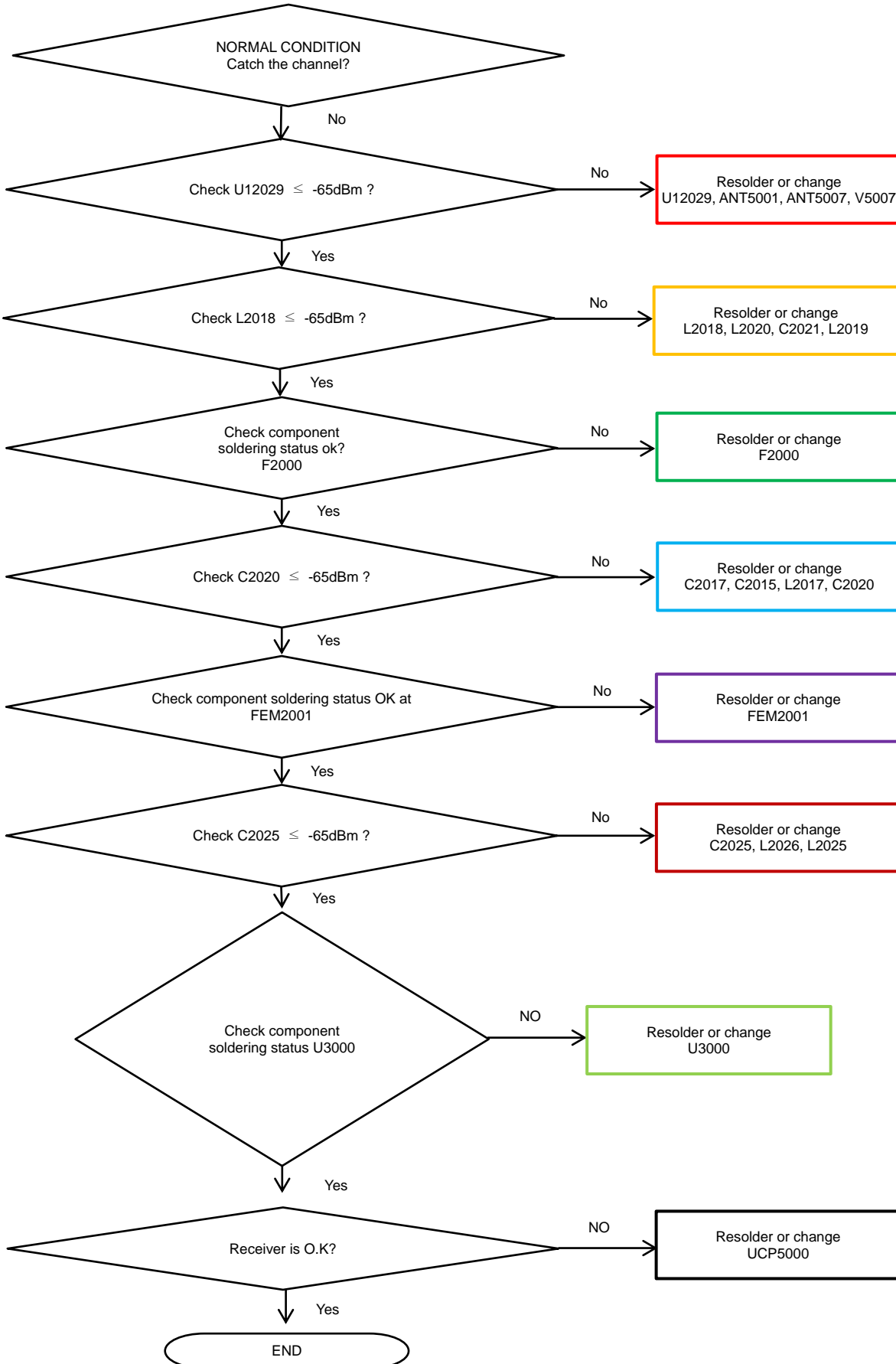

8. Level 3 Repair

8-4-33. GSM 850/900 TX

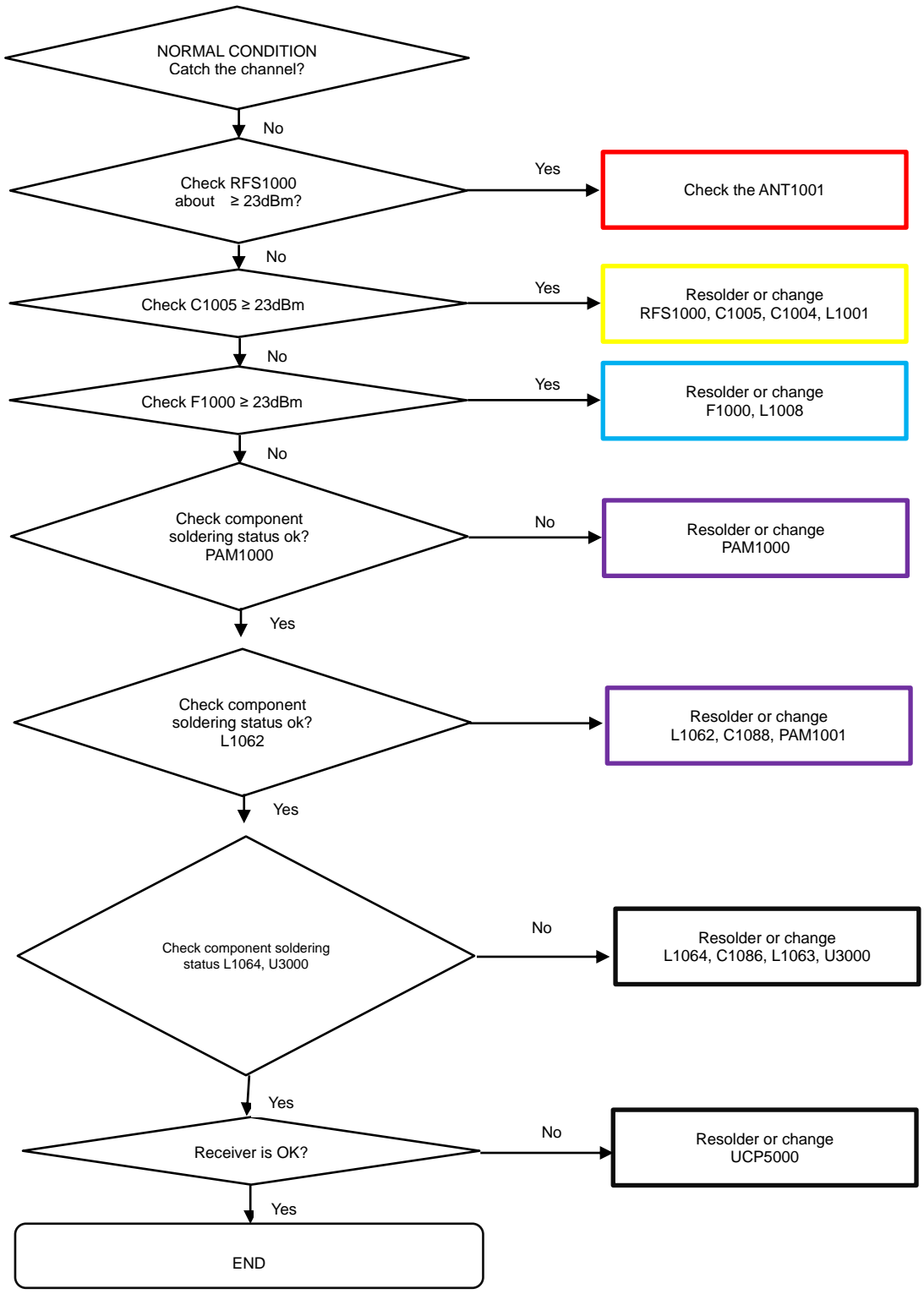

8. Level 3 Repair

8-4-34. GSM 1800/1900 TX

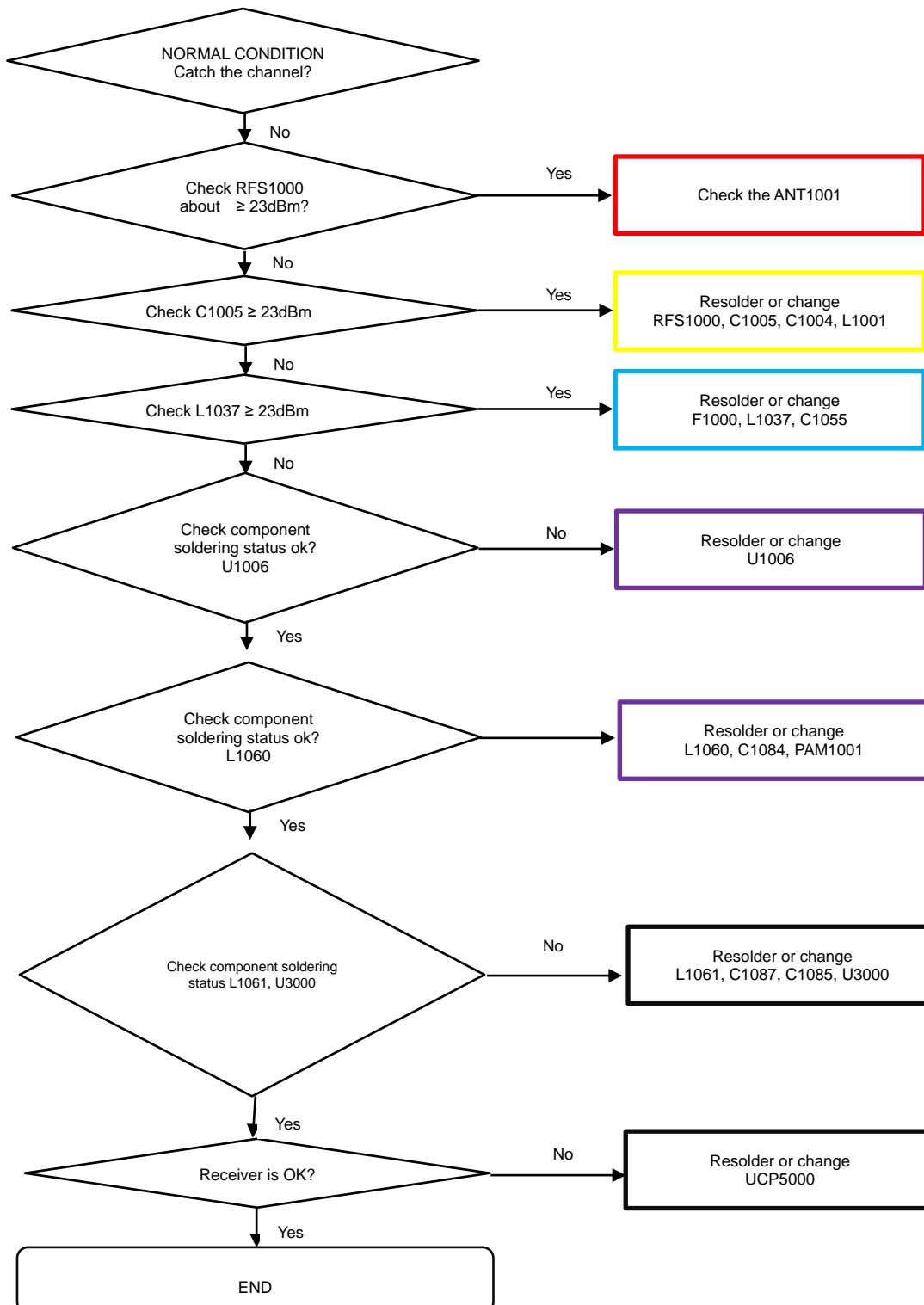

8. Level 3 Repair

8-4-35. WCDMA B5/8, LTE B5/8/12/13/17/18/19/20/26/28 TX

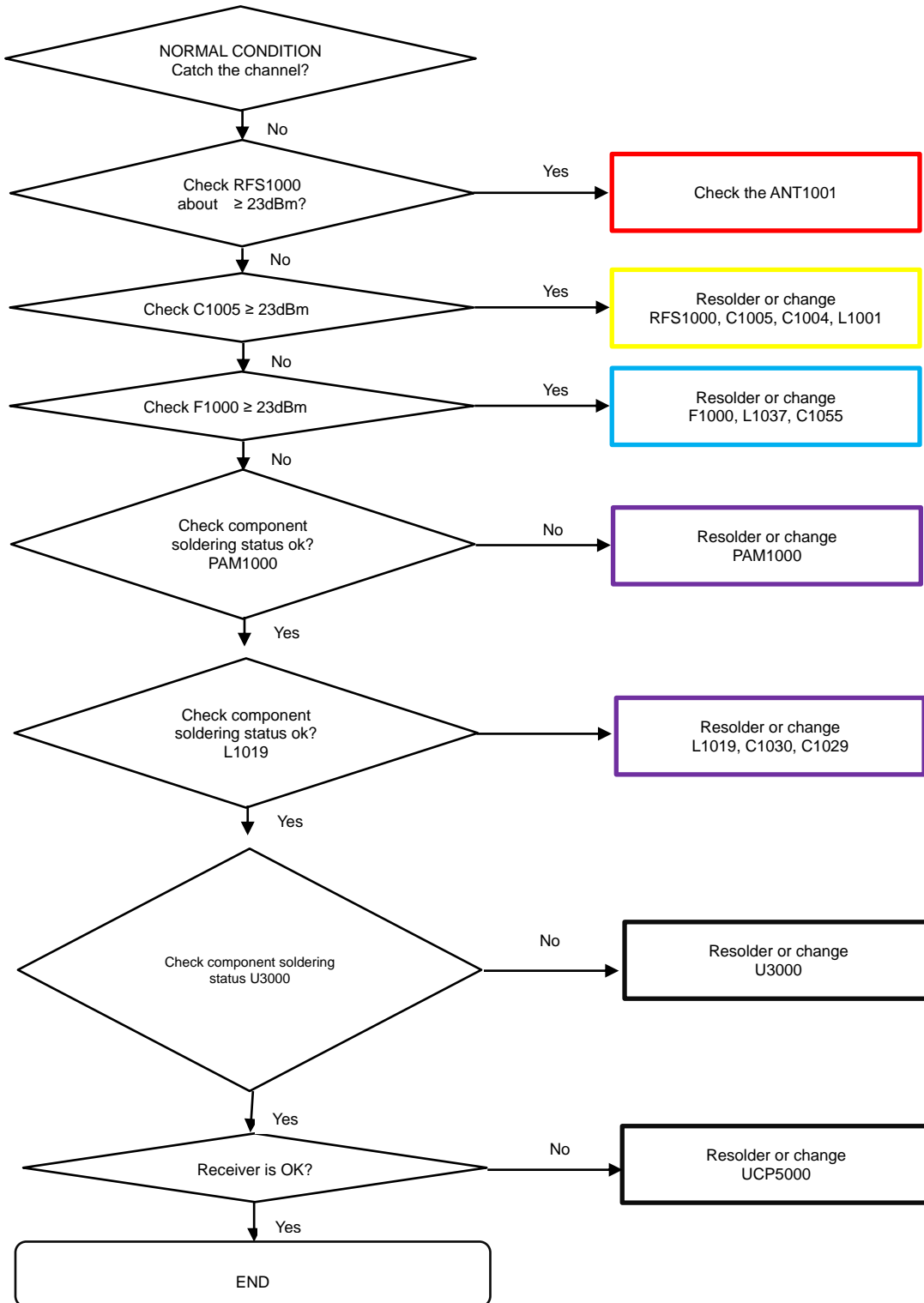

8. Level 3 Repair

8-4-36. WCDMA B1/2/4, TDSCDMA B34/39, LTE B1/2/3/4/25/66 TX

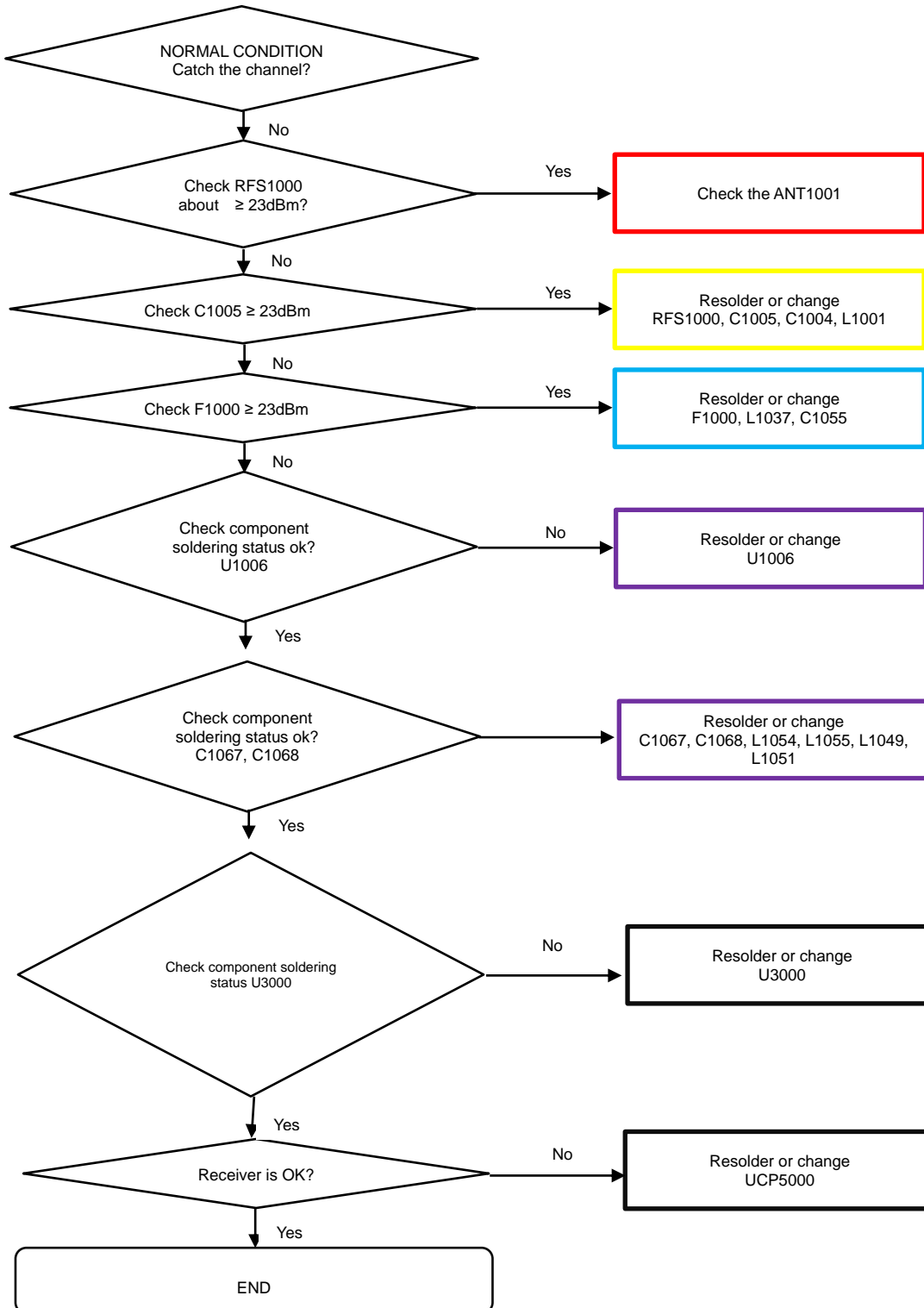

8. Level 3 Repair

8-3-37. LTE TDD 38/40/41 DRX

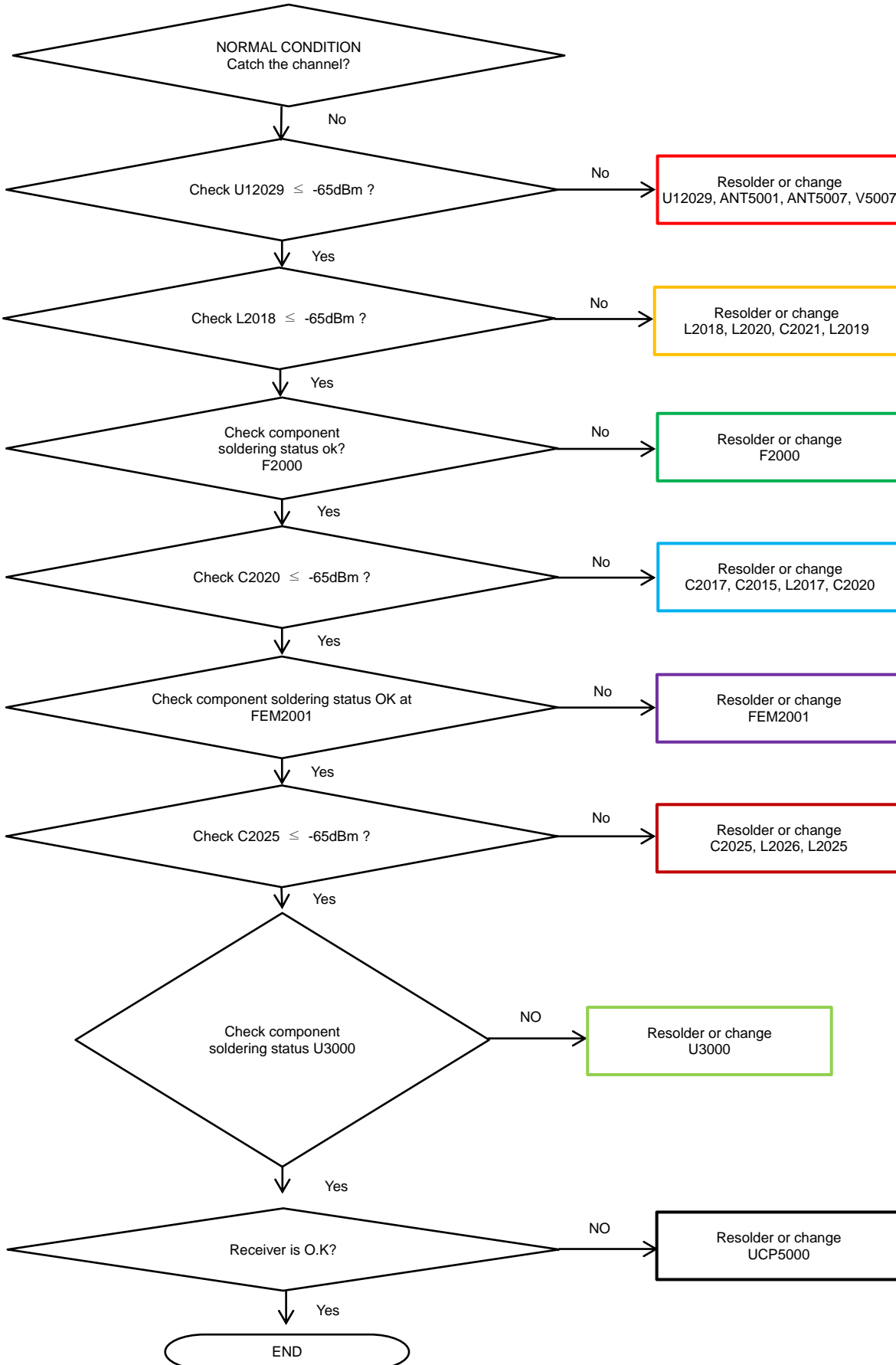

8. Level 3 Repair

8-4-38. GSM 850/900 TX

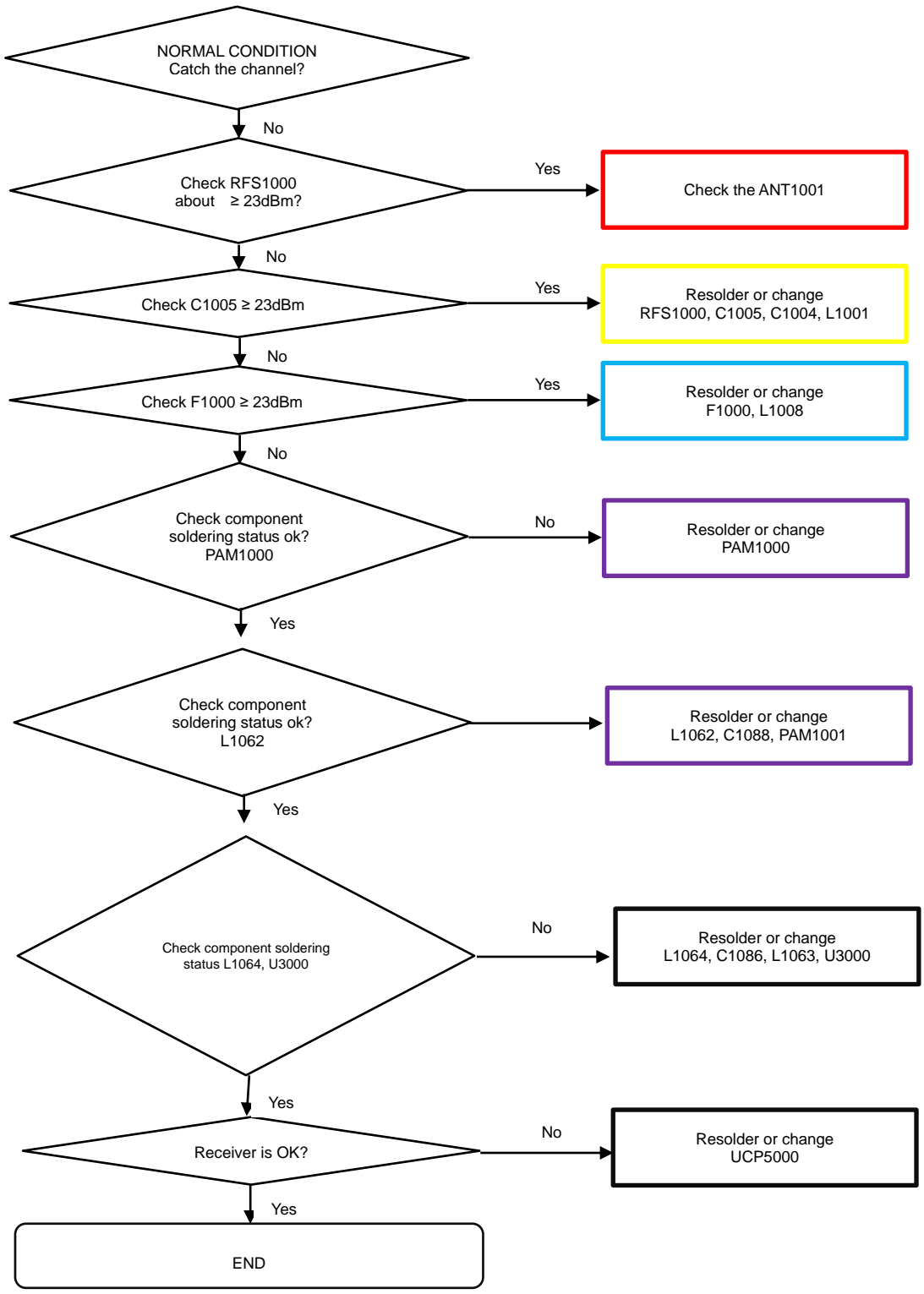

8. Level 3 Repair

8-4-39. GSM 1800/1900 TX

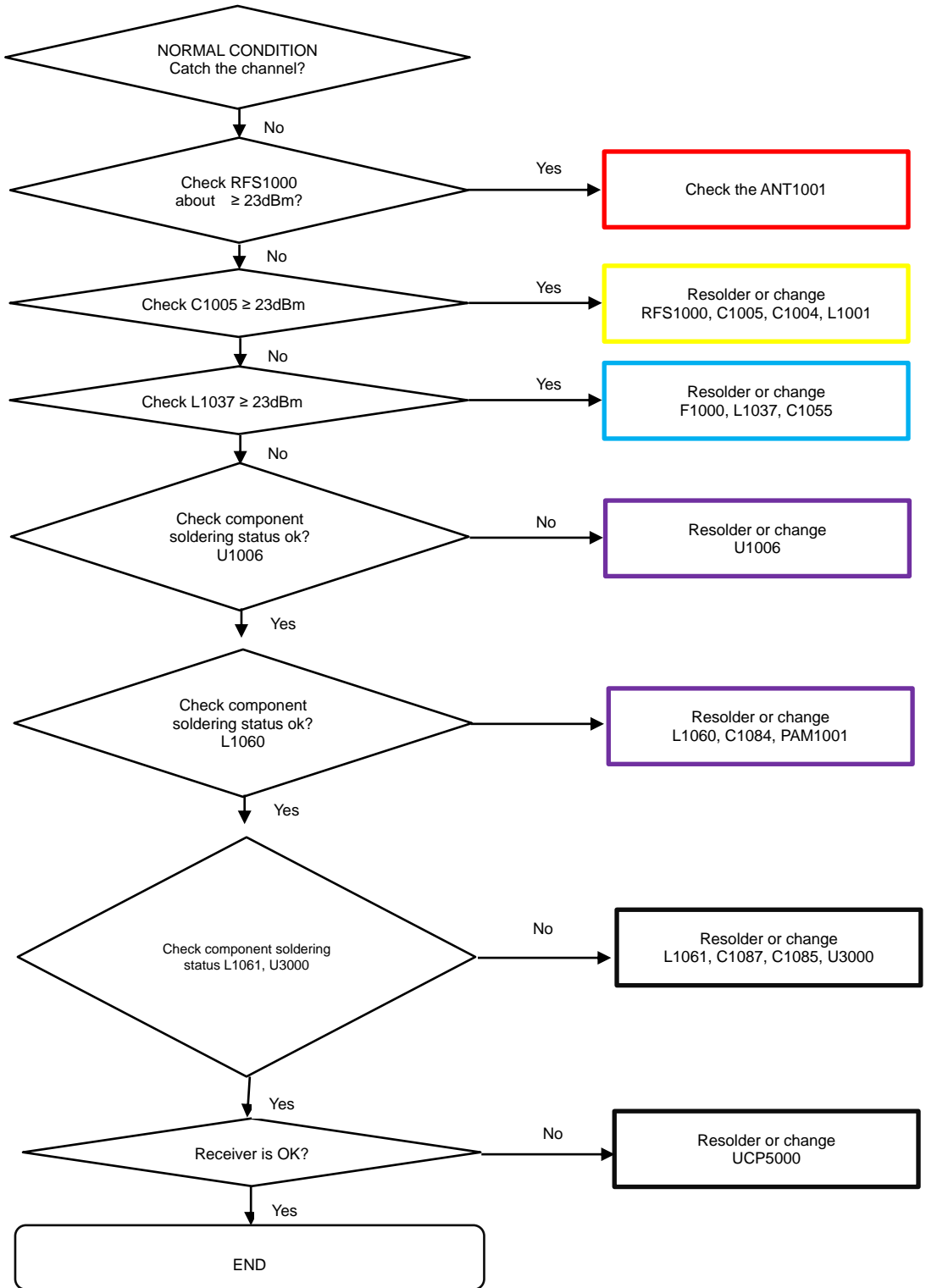

8. Level 3 Repair

8-4-40. WCDMA B5/8, LTE B5/8/12/13/17/18/19/20/26/28 TX

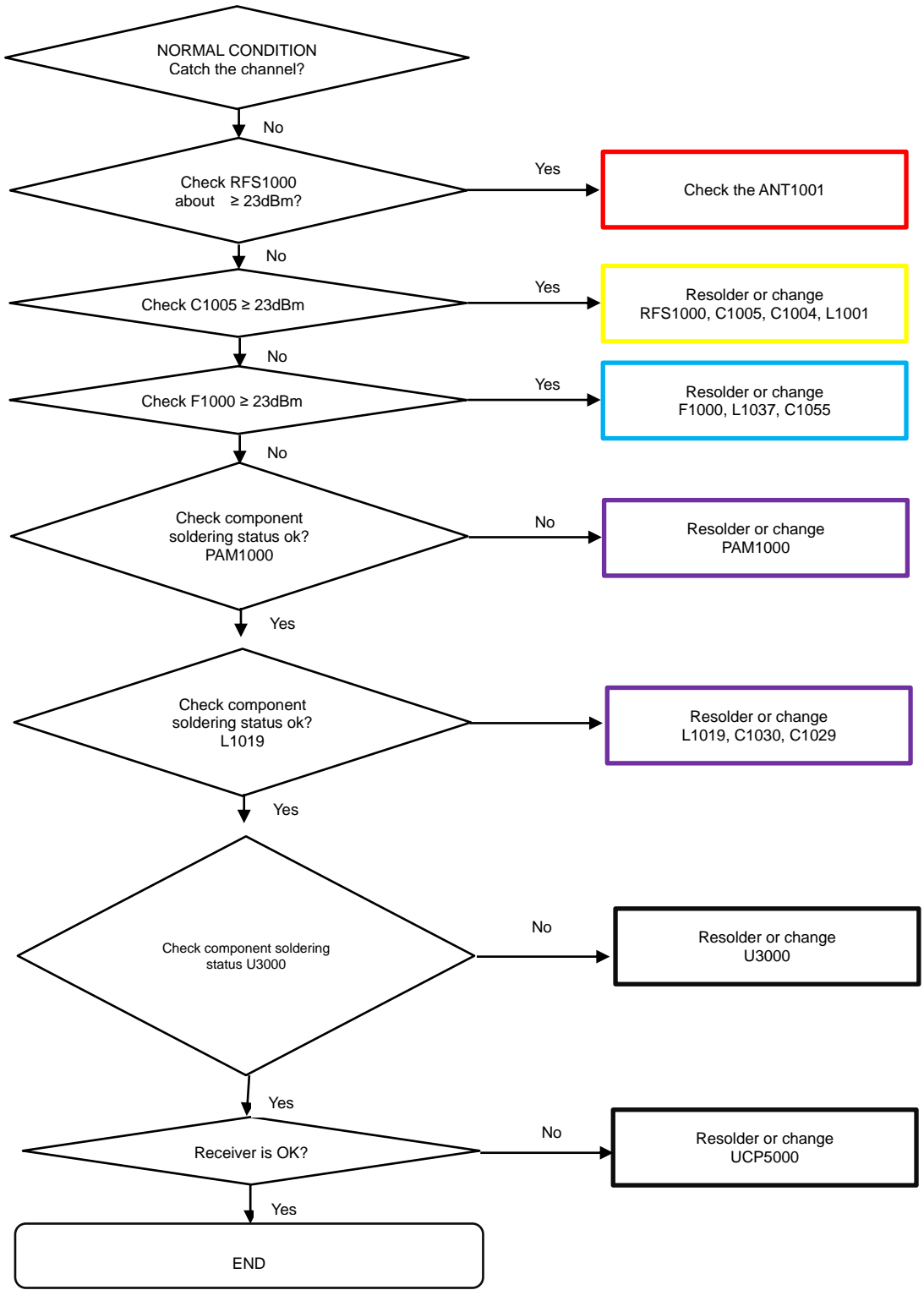

8. Level 3 Repair

8-4-41. LTE B7/38/40/41 TX

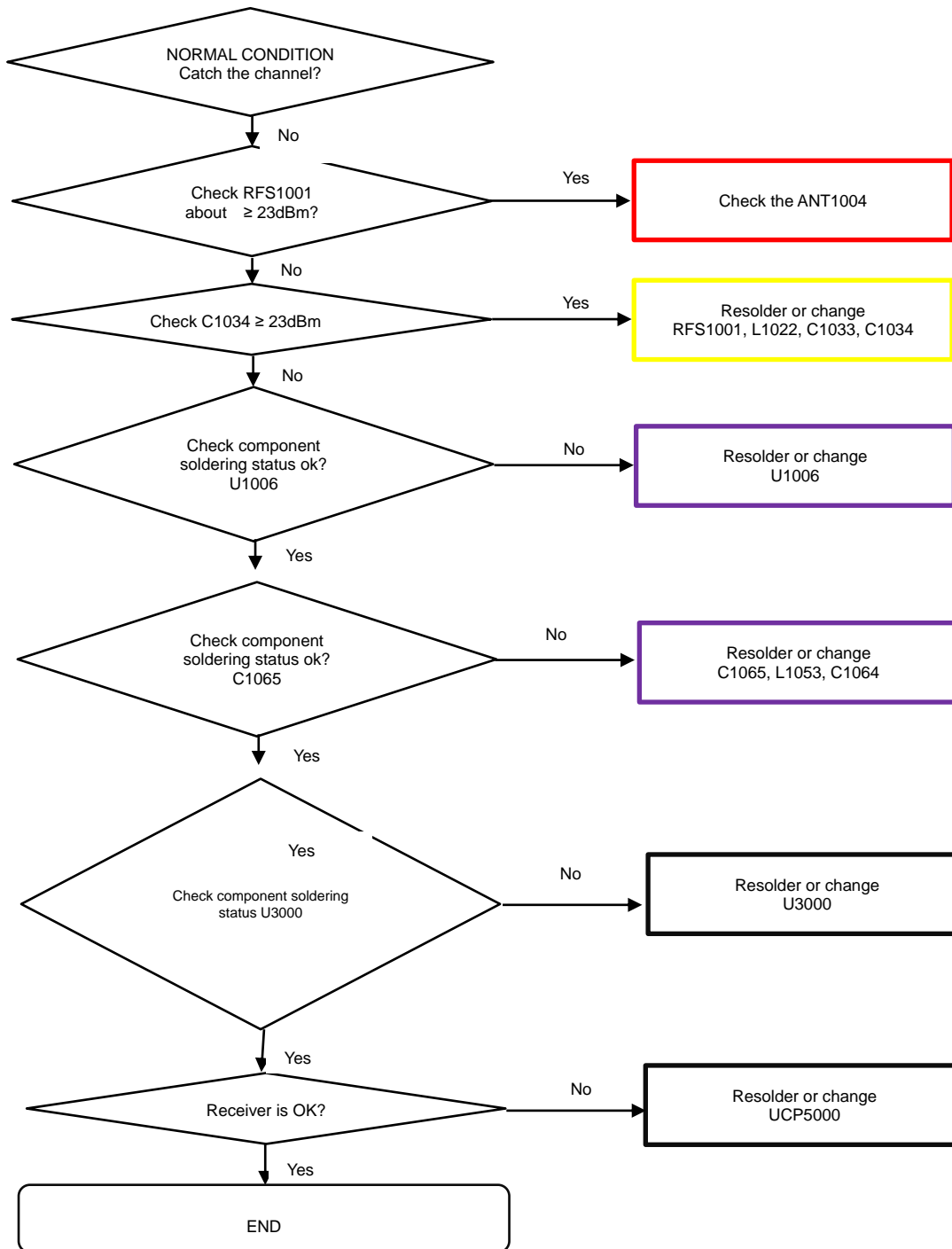

8. Level 3 Repair

8-4-42. Dex Station

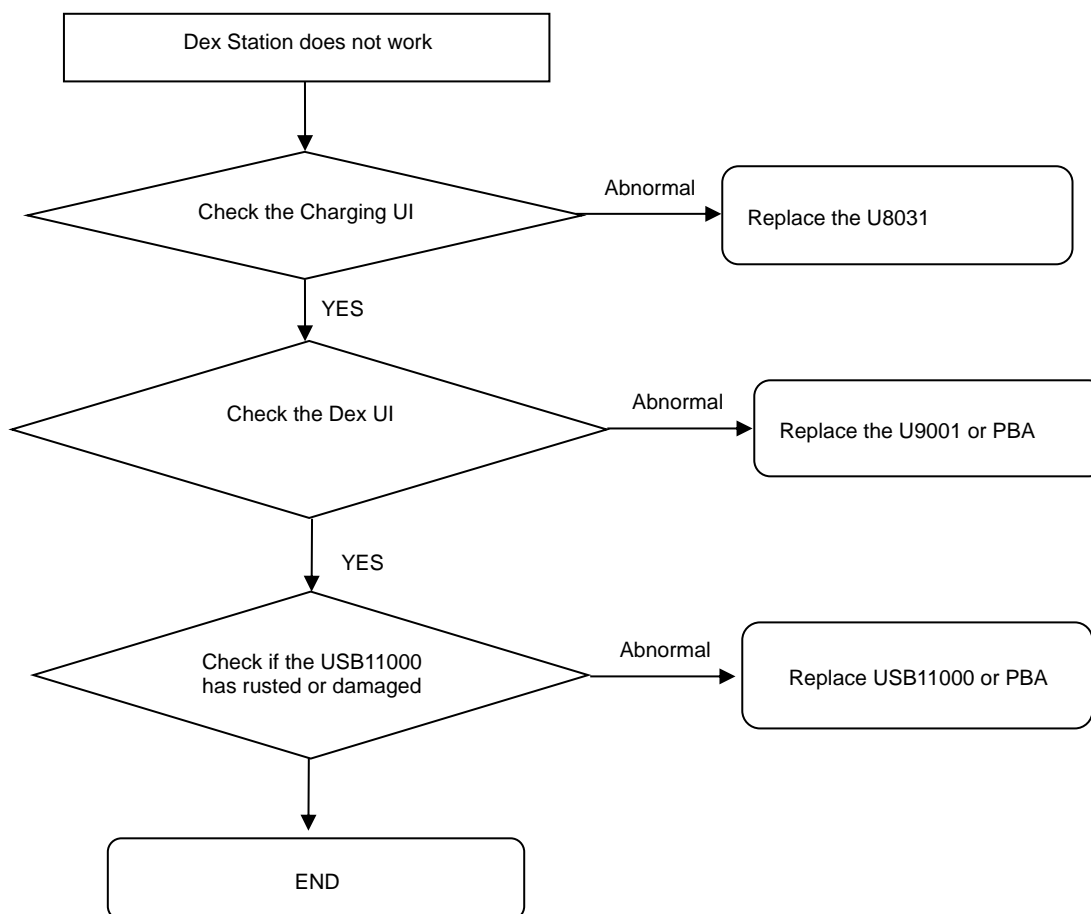

9. Reference Abbreviation

Reference Abbreviation

- **AAC**: Advanced Audio Coding.
- **AVC** : Advanced Video Coding.
- **BER** : Bit Error Rate
- **BPSK**: Binary Phase Shift Keying
- **CA** : Conditional Access
- **CDM** : Code Division Multiplexing
- **C/I** : Carrier to Interference
- **DMB** : Digital Multimedia Broadcasting
- **EN** : European Standard
- **ES** : Elementary Stream
- **ETSI**: European Telecommunications Standards Institute
- **MPEG**: Moving Picture Experts Group
- **PN** : Pseudo-random Noise
- **PS** : Pilot Symbol
- **QPSK**: Quadrature Phase Shift Keying
- **RS** : Reed-Solomon
- **SI** : Service Information
- **TDM** : Time Division Multiplexing
- **TS** : Transport Stream

SAMSUNG